

SONY®

4-290-338-11 (1)

Video Projector

<http://www.sony.net/>

Printed on recycled paper.

Sony Corporation Printed in Japan

Operating Instructions

VPL-HW30ES/HW30AES

SXRD **HDMI**
Silicon X-tal Reflective Display

© 2011 Sony Corporation



4290338110

WARNING

To reduce the risk of fire or electric shock, do not expose this apparatus to rain or moisture.

To avoid electrical shock, do not open the cabinet. Refer servicing to qualified personnel only.

THIS APPARATUS MUST BE EARTHED.

AVERTISSEMENT

Afin de réduire les risques d'incendie ou d'électrocution, ne pas exposer cet appareil à la pluie ou à l'humidité.

Afin d'écartier tout risque d'électrocution, garder le coffret fermé. Ne confier l'entretien de l'appareil qu'à un personnel qualifié.

CET APPAREIL DOIT ÊTRE RELIÉ À LA TERRE.

WARNING

Um die Gefahr von Bränden oder elektrischen Schlägen zu verringern, darf dieses Gerät nicht Regen oder Feuchtigkeit ausgesetzt werden.

Um einen elektrischen Schlag zu vermeiden, darf das Gehäuse nicht geöffnet werden. Überlassen Sie

Wartungsarbeiten stets nur qualifiziertem Fachpersonal.

DIESES GERÄT MUSS GEERDET WERDEN.

For the customers in the U.S.A. and Canada

WARNING:

Using this unit at a voltage other than 120 V may require the use of a different line cord or attachment plug, or both. To reduce the risk of fire or electric shock, refer servicing to qualified service personnel.

For the customers in the U.S.A.

This equipment has been tested and found to comply with the limits for a Class B digital device, pursuant to Part 15 of the FCC Rules. These limits are designed to provide reasonable protection against harmful interference in a residential installation. This equipment generates, uses, and can radiate radio frequency energy and, if not installed and used in accordance with the instructions, may cause harmful interference to radio communications. However, there is no guarantee that interference will not occur in a particular installation. If this equipment does cause harmful interference to radio or television reception, which can be determined by turning the equipment off and on, the user is encouraged to try to correct the interference by one or more of the following measures:

- Reorient or relocate the receiving antenna.
- Increase the separation between the equipment and receiver.
- Connect the equipment into an outlet on a circuit different from that to which the receiver is connected.
- Consult the dealer or an experienced radio/TV technician for help.

You are cautioned that any changes or modifications not expressly approved in this manual could void your authority to operate this equipment.

All interface cables used to connect peripherals must be shielded in order to comply with the limits for a digital device pursuant to Subpart B of Part 15 of FCC Rules.

If you have any questions about this product, you may call;
Sony Customer Information Service Center
1-800-222-7669 or <http://www.sony.com/>

Declaration of Conformity

Trade Name: SONY
Model: VPL-HW30ES
VPL-HW30AES
Responsible party: Sony Electronics Inc.
Address: 16530 Via Esprillo,
San Diego, CA 92127
U.S.A.
Telephone Number: 858-942-2230

This device complies with part 15 of the FCC Rules. Operation is subject to the following two conditions: (1) this device may not cause harmful interference, and (2) this device must accept any interference received, including interference that may

For the customers in Canada

This Class B digital apparatus complies with Canadian ICES-003.

Pour les clients au Canada

Cet appareil numérique de la classe B est conforme à la norme NMB-003 du Canada.

For the customers in Europe

The manufacturer of this product is Sony Corporation, 1-7-1 Konan, Minato-ku, Tokyo, 108-0075 Japan.

The Authorized Representative for EMC and product safety is Sony Deutschland GmbH, Hedelfinger Strasse 61, 70327 Stuttgart, Germany. For any service or guarantee matters please refer to the addresses given in separate service or guarantee documents.

Pour les clients en Europe

Le fabricant de ce produit est Sony Corporation, 1-7-1 Konan, Minato-ku, Tokyo, 108-0075 Japon.

Le représentant autorisé pour EMC et la sécurité des produits est Sony Deutschland GmbH, Hedelfinger Strasse 61, 70327 Stuttgart, Allemagne. Pour toute question concernant le service ou la garantie, veuillez consulter les adresses indiquées dans les documents de service ou de garantie séparés.

Für Kunden in Europa

Der Hersteller dieses Produkts ist Sony Corporation, 1-7-1 Konan, Minato-ku, Tokyo, 108-0075 Japan.

Der autorisierte Repräsentant für EMV und Produktsicherheit ist Sony Deutschland GmbH, Hedelfinger Strasse 61, 70327 Stuttgart, Deutschland. Bei jeglichen Angelegenheiten in Bezug auf Kundendienst oder Garantie wenden Sie sich bitte an die in den separaten Kundendienst- oder Garantiedokumenten aufgeführten Anschriften.

For kundene i Norge

Dette utstyret kan kobles til et IT-strømfordelingssystem.

Für Kunden in Deutschland

Entsorgungshinweis: Bitte werfen Sie nur entladene Batterien in die Sammelboxen beim Handel oder den Kommunen. Entladen sind Batterien in der Regel dann, wenn das Gerät abschaltet und signalisiert „Batterie leer“ oder nach längerer Gebrauchsdauer der Batterien „nicht mehr einwandfrei funktioniert“. Um sicherzugehen, kleben Sie die Batteriepole z.B. mit einem Klebestreifen ab oder geben Sie die Batterien einzeln in einen Plastikbeutel.

For the customers in Taiwan only



廢電池請回收

For the Customers in Brazil only

DESCARTE DE PILHAS E BATERIAS

Após o uso, as pilhas e/ou baterias poderão ser entregues ao estabelecimento comercial ou rede de assistência técnica autorizada.



Bateria Primária

Atenção:

Verifique as instruções de uso do aparelho certificando-se de que as polaridades (+) e (-) estão no sentido indicado. As pilhas poderão vazar ou explodir se as polaridades forem invertidas, expostas ao fogo, desmontadas ou recarregadas.

Evite misturar com pilhas de outro tipo ou com pilhas usadas, transportá-las ou armazená-las soltas, pois aumenta o risco de vazamento.

Retire as pilhas caso o aparelho não esteja sendo utilizado, para evitar possíveis danos na eventualidade de ocorrer vazamento.

As pilhas devem ser armazenadas em local seco e ventilado.

No caso de vazamento da pilha, evite o contato com a mesma. Lave qualquer parte do corpo afetado com água abundante. Ocorrendo irritação, procure auxílio médico.

Não remova o invólucro da pilha.

Mantenha fora do alcance das crianças. Em caso de ingestão procure auxílio médico imediatamente.

Table of Contents

Precautions	7
-------------------	---

Location of Controls

Front/Right Side	8
Rear/Bottom	9
Remote Control	10

Connections and Preparations

Unpacking	11
Step 1: Installing the Projector	13
Before Setting Up the Projector	13
Positioning the Projector and a screen	16
Step 2: Adjusting the Picture Position	20
Step 3: Connecting the Projector	25
Connecting to a VCR	25
Connecting to a Computer	27
Connecting to an Optional TMR-PJ1 3D Sync Transmitter*	28
Step 4: Selecting the Menu Language	29

Projecting

Projecting the Picture on the Screen	31
Turning Off the Power	32
Selecting the Wide Screen Mode	33
Watching 3D Video Images	35

Using the Simulated 3D Function	36
Using the 3D Glasses	37
Selecting the Picture Viewing Mode	38
Adjusting the Picture Quality	39
Selecting to Directly Adjust the Desired Menu Item	39
Adjusting the Picture Using Real Color Processing	40

Using the Menus

Operation through the Menu	42
Picture Menu	46
Advanced Picture Menu	50
Screen Menu	51
Setup Menu	53
Function Menu	55
Installation Menu	58
Information Menu	60
About the Preset Memory No. ...	61

Others

About the Control for HDMI	62
About the x.v.Color	62
About the simulated 3D feature	63
Troubleshooting	64
Warning Indicators	67
Message Lists	68
Replacing the Lamp and the Air Filter and Cleaning the Ventilation Holes (intake)	69
Cleaning the Air Filter	72

Fitting the Lens Cap 72

Cleaning and the Screen of the
Projector 73

How to Use the USB Charging
AC Power Adaptor 73

Specifications 75

 Preset Signals 77

 Input Signals and Adjustable/
 Setting Items 79

 Compatible 3D Signals 81

 3D Signals and Adjustable/
 Setting Items 81

Ceiling Installation 83

Index 87

Trademark Information

“PS3” is a registered trademark of Sony Computer Entertainment Inc.

HDMI, the HDMI logo and High-Definition Multimedia Interface are trademarks or registered trademarks of HDMI Licensing LLC.

“Blu-ray” and “Blu-ray Disk” are trademarks of Blu-ray Disc Association.

.....
Control for HDMI is an HDMI standard mutual control function which uses the HDMI CEC (Consumer Electronics Control) specification. This projector supports DeepColor, x.v.Color, LipSync, 3D signal and computer input signal of HDMI standards. It also supports HDCP.

Precautions

On safety

- Check that the operating voltage of your unit is identical with the voltage of your local power supply.
- Should any liquid or solid object fall into the cabinet, unplug the unit and have it checked by qualified personnel before operating it further.
- Unplug the unit from the wall outlet if it is not to be used for several days.
- To disconnect the cord, pull it out by the plug. Never pull the cord itself.
- The wall outlet should be near the unit and easily accessible.
- The unit is not disconnected to the AC power source (mains) as long as it is connected to the wall outlet, even if the unit itself has been turned off.
- Do not look into the lens while the lamp is on.
- Do not place your hand or objects near the ventilation holes. The air coming out is hot.

On preventing internal heat build-up

After you turn off the power with the I/⏻ (ON/STANDBY) switch, do not disconnect the unit from the wall outlet while the cooling fan is still running.

Caution

The projector is equipped with ventilation holes (intake) and ventilation holes (exhaust). Do not block or place anything near these holes, or internal heat build-up may occur, causing picture degradation or damage to the projector.

On repacking

Save the original shipping carton and packing material; they will come in handy if you ever have to ship your unit. For maximum protection, repack your unit as it was originally packed at the factory.

Location of Controls

Front/Right Side

You can use the buttons on the control panel with the same names as those on the remote control to operate the projector.

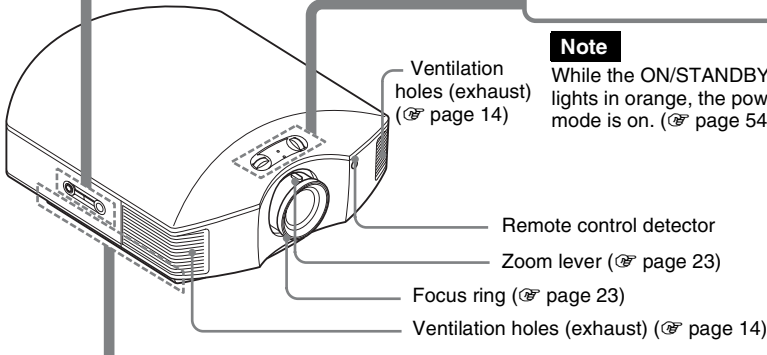
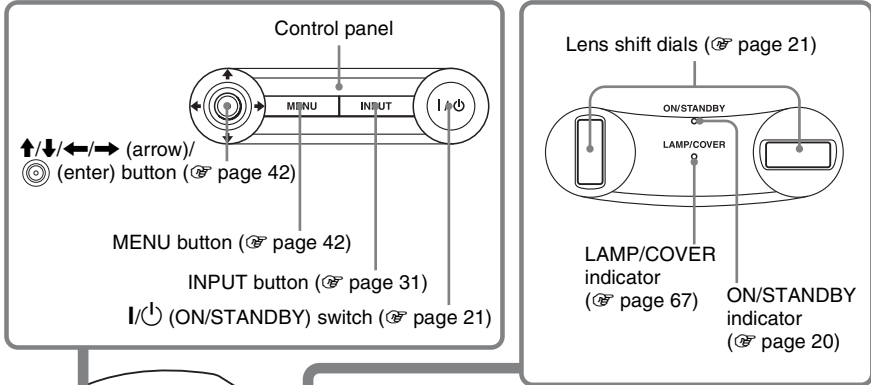

Note

While the ON/STANDBY indicator lights in orange, the power saving mode is on. (☞ page 54)

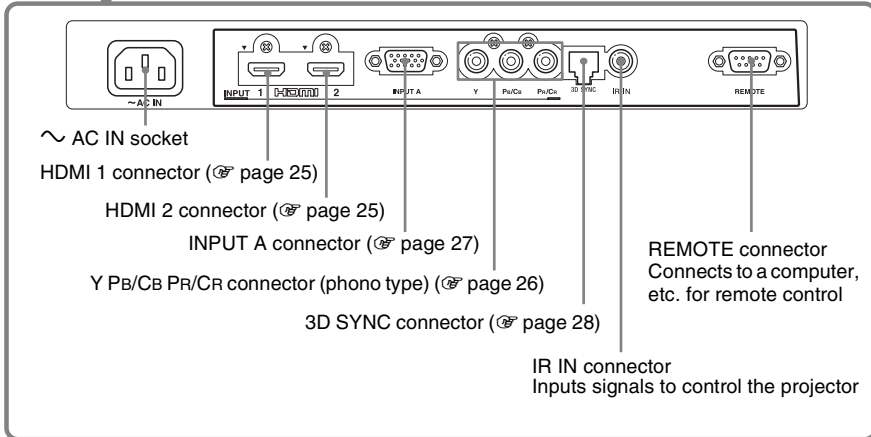

Rear/Bottom

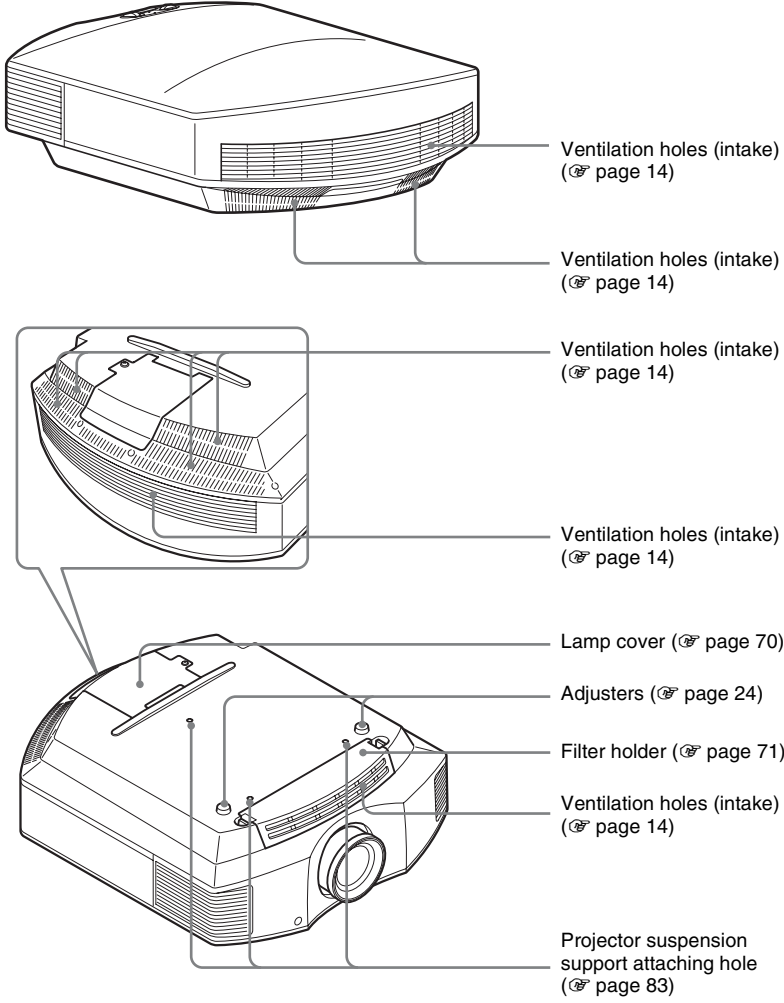

Remote Control

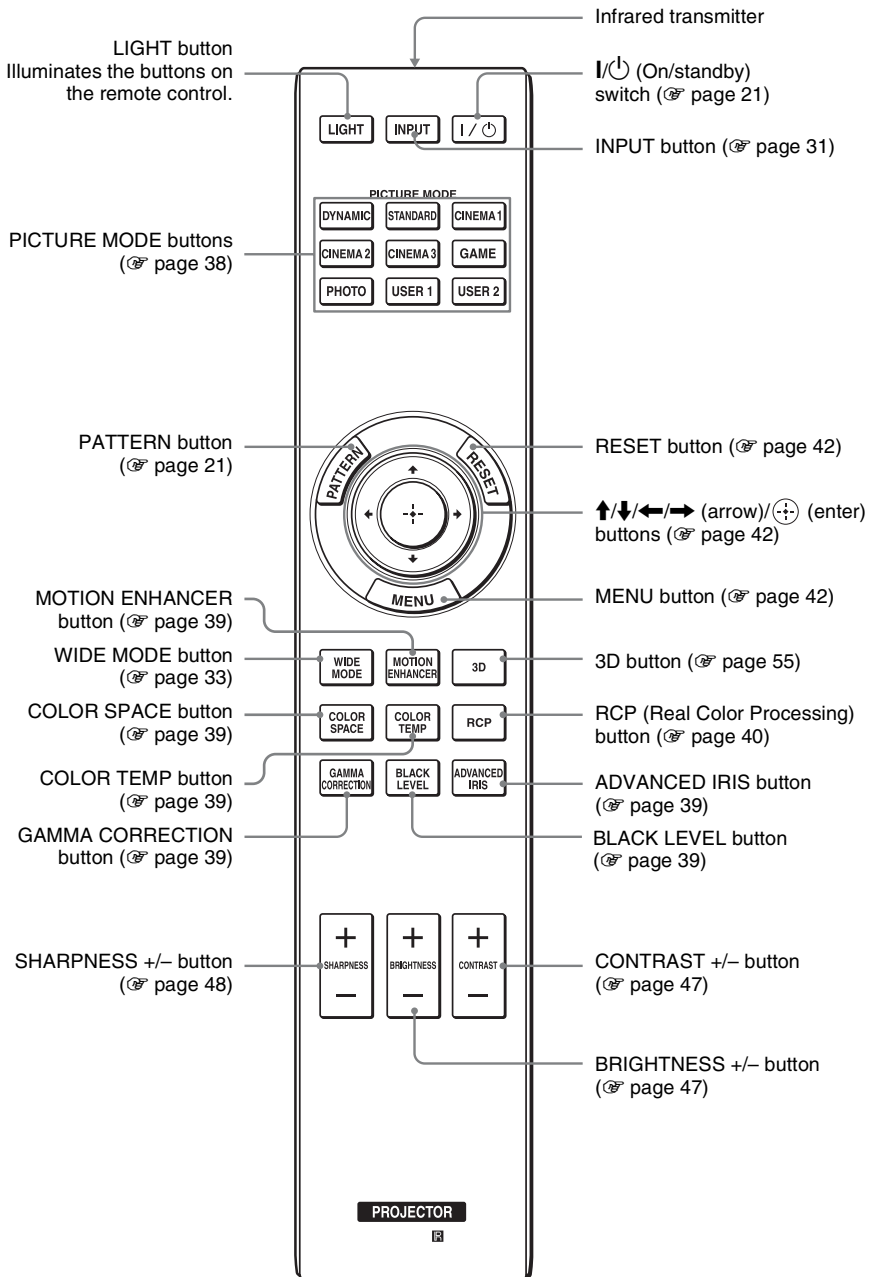

Connections and Preparations

This section describes how to install the projector and screen, how to connect the equipment from which you want to project the picture, etc.

Unpacking

Check the carton to make sure it contains the following items:

- Remote control (1) and
Size AA (R6) manganese batteries (2)

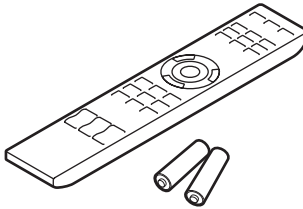

- AC power cord (1)
- Lens cap (1)

When you have purchased the projector, the lens cap is put onto the lens. Remove this lens cap when you use the projector.

- USB charging AC power adaptor (1)
- Operating Instructions (this manual)

For VPL-HW30AES, the following items are also contained.

- 3D glasses (2)
- USB charging cable (1)
- Pouch for the 3D glasses (2)
- 3D Sync Transmitter (1)

Inserting the batteries into the remote control

Insert the batteries  side first as shown in the illustration. Inserting them forcibly or with the polarities reversed may cause a short circuit and may generate heat.

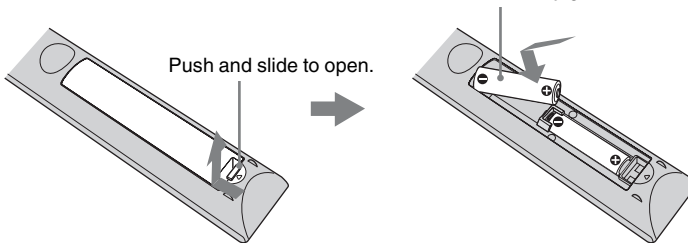

CAUTION

Danger of explosion if battery is incorrectly replaced.

Replace only with the same or equivalent type recommended by the manufacturer.

When you dispose of the battery, you must obey the law in the relative area or country.

ATTENTION

Il y a danger d'explosion s'il y a remplacement incorrect de la batterie. Remplacer uniquement avec une batterie du même type ou d'un type équivalent recommandé par le constructeur.

Lorsque vous mettez la batterie au rebut, vous devez respecter la législation en vigueur dans le pays ou la région où vous vous trouvez.

VORSICHT

Explosionsgefahr bei Verwendung falscher Batterien. Batterien nur durch den vom Hersteller empfohlenen oder einen gleichwertigen Typ ersetzen.

Wenn Sie die Batterie entsorgen, müssen Sie die Gesetze der jeweiligen Region und des jeweiligen Landes befolgen.

Installing batteries

Two size AA (R6) batteries are supplied for Remote Control.

To avoid risk of explosion, use size AA (R6) manganese or alkaline batteries.

Caution about handling the remote control

- Handle the remote control with care. Do not drop or step on it, or spill liquid of any kind onto it.
- Do not place the remote in a location near a heat source, a place subject to direct sunlight, or a damp room.

Step 1: Installing the Projector

The projector displays pictures output from a VCR or other device.

The lens shift allows you to have broader options for placing the projector and viewing pictures easily.

Before Setting Up the Projector

Unsuitable installation

Do not place the projector in the following situations, which may cause malfunction or damage to the projector.

Poorly ventilated location

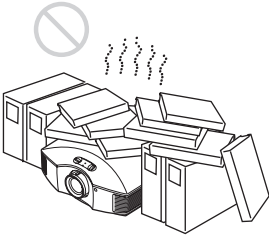

Leave space of more than 30 cm (11 ⁷/₈ inches) around the unit.

Hot and humid

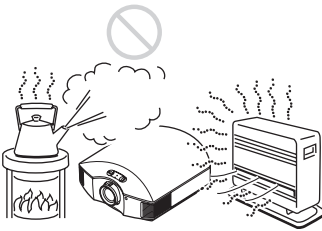

Locations subject to direct cool or warm air from an air-conditioner

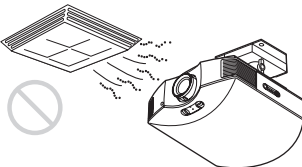

Installing the projector in such a location may cause a malfunction of the unit due to moisture condensation or rise in temperature.

Near a heat or smoke sensor

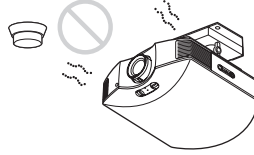

Malfunction of the sensor may occur.

Very dusty and extremely smoky locations



Install in a location away from walls

To maintain the performance and reliability of the projector, allow at least 30 cm (11 ⁷/₈ inches) between the projector and walls.

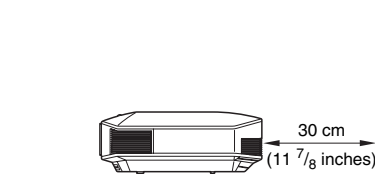
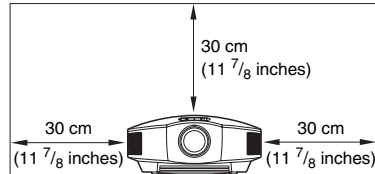

Improper use

Do not do any of the following while using the projector.

Blocking the ventilation holes (intake or exhaust)

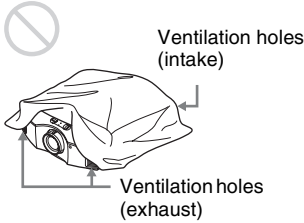

Tip

For details on the location of the ventilation holes (intake or exhaust), see “Location of Controls” (☞ page 8).

Tilting front/rear and left/right

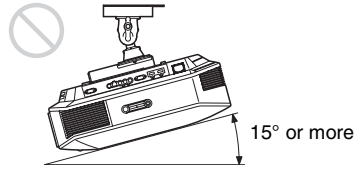
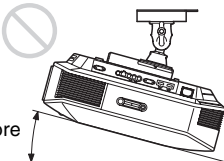
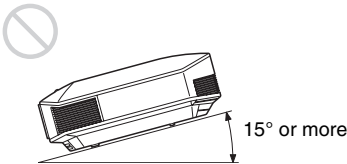
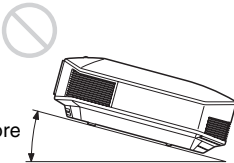
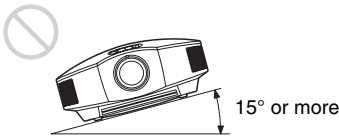

Avoid using the projector tilted at an angle of more than 15 degrees.

Do not install the projector anywhere other than on a level surface or on the ceiling. Installing the projector in such a location may result in uneven color uniformity or reduce the reliability of the effects of the lamp.

If the projector is tilted up or down, the image on the screen may be trapezoidal. Position the projector so that the lens is parallel to the screen (☞ page 19).

When installing the unit at altitudes

When using the projector at an altitude of 1,500 m or higher, set “Cooling Setting” in the Setup  menu to “High” (☞ page 53). Failing to set this mode when using the projector at high altitudes could have adverse effects, such as reducing the reliability of certain components.

WARNING

When installing the unit, incorporate a readily accessible disconnect device in the fixed wiring, or connect the power plug to an easily accessible socket-outlet near the unit. If a fault should occur during operation of the unit, operate the disconnect device to switch the power supply off, or disconnect the power plug.

AVERTISSEMENT

Lors de l'installation de l'appareil, incorporer un dispositif de coupure dans le câblage fixe ou brancher la fiche d'alimentation dans une prise murale facilement accessible proche de l'appareil. En cas de problème lors du fonctionnement de l'appareil, enclencher le dispositif de coupure d'alimentation ou débrancher la fiche d'alimentation.

WARNUNG

Beim Einbau des Geräts ist daher im Festkabel ein leicht zugänglicher Unterbrecher einzufügen, oder der Netzstecker muss mit einer in der Nähe des Geräts befindlichen, leicht zugänglichen Wandsteckdose verbunden werden. Wenn während des Betriebs eine Funktionsstörung auftritt, ist der Unterbrecher zu betätigen bzw. der Netzstecker abzuziehen, damit die Stromversorgung zum Gerät unterbrochen wird.

Positioning the Projector and a screen

The installation distance between the projector and a screen varies depending on the size of the screen or whether or not you use the lens shift features.

1 Determine the installation position of the projector and screen.

You can obtain a good quality picture if you position the projector so that the center of the lens is within the area indicated in gray in the illustration.

Use the values L , x and y in the table on page 15 or 16 as a guide.

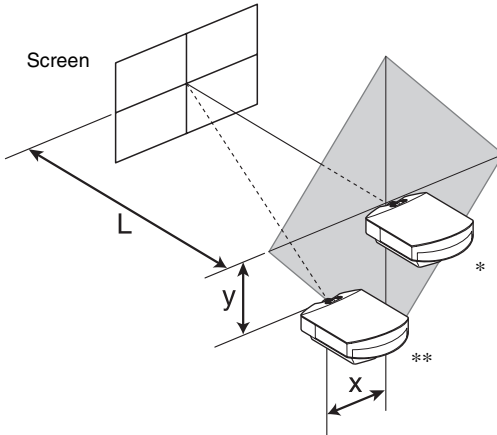

* Installation position not using lens shift ($x = 0$, $y = 0$)

** Example of installation position using lens shift (x , y)

L: Distance between the screen and the front end of the projector's lens.

x: Horizontal distance between the center of the screen and the center of the projector's lens.

y: Vertical distance between the center of the screen and the center of the projector's lens.

For installation of the projector on a ceiling, see “Ceiling Installation.”
(☞ page 83)

For details on the lens shift feature, see “Step 2: Adjusting the Picture Position.”
(☞ page 20)

When using the 16:9 aspect ratio screen size

Screen Size SS (inches)		40	60	80	100	120	150	200	250	300
(mm)		1016	1524	2032	2540	3048	3810	5080	6350	7620
L	minimum	1201 (47 3/8)	1825 (71 7/8)	2448 (96 1/2)	3072 (121)	3695 (145 1/2)	4631 (182 3/8)	6189 (243 3/4)	7748 (305 1/8)	9307 (366 1/2)
	maximum	1840 (72 1/2)	2782 (109 5/8)	3723 (146 5/8)	4664 (183 5/8)	5605 (220 3/4)	7017 (276 3/8)	9371 (369)	11724 (461 5/8)	14077 (554 1/4)
x		0 (0)	0 (0)	0 (0)	0 (0)	0 (0)	0 (0)	0 (0)	0 (0)	0 (0)
y		324 (12 7/8)	486 (19 1/4)	648 (25 5/8)	809 (31 7/8)	971 (38 1/4)	1214 (47 7/8)	1619 (63 3/4)	2024 (79 3/4)	2428 (95 5/8)
x		44 (1 3/4)	66 (2 5/8)	89 (3 5/8)	111 (4 3/8)	133 (5 1/4)	166 (6 5/8)	221 (8 3/4)	277 (11)	332 (13 1/8)
y		259 (10 1/4)	389 (15 3/8)	518 (20 1/2)	648 (25 5/8)	777 (30 5/8)	971 (38 1/4)	1295 (51)	1619 (63 3/4)	1943 (76 1/2)
x		89 (3 5/8)	133 (5 1/4)	177 (7)	221 (8 3/4)	266 (10 1/2)	332 (13 1/8)	443 (17 1/2)	553 (21 7/8)	664 (26 1/4)
y		194 (7 3/4)	291 (11 1/2)	389 (15 3/8)	486 (19 1/4)	583 (23)	728 (28 3/4)	971 (38 1/4)	1214 (47 7/8)	1457 (57 3/8)
x		133 (5 1/4)	199 (7 7/8)	266 (10 1/2)	332 (13 1/8)	398 (15 3/4)	498 (19 5/8)	664 (26 1/4)	830 (32 3/4)	996 (39 1/4)
y		130 (5 1/8)	194 (7 3/4)	259 (10 1/4)	324 (12 7/8)	389 (15 3/8)	486 (19 1/4)	648 (25 5/8)	809 (31 7/8)	971 (38 1/4)
x		177 (7)	266 (10 1/2)	354 (14)	443 (17 1/2)	531 (21)	664 (26 1/4)	886 (35)	1107 (43 5/8)	1328 (52 3/8)
y		65 (2 5/8)	97 (3 7/8)	130 (5 1/8)	162 (6 1/2)	194 (7 3/4)	243 (9 5/8)	324 (12 7/8)	405 (16)	486 (19 1/4)
x		221 (8 3/4)	332 (13 1/8)	443 (17 1/2)	553 (21 7/8)	664 (26 1/4)	830 (32 3/4)	1107 (43 5/8)	1384 (54 1/2)	1660 (65 3/8)
y		0 (0)	0 (0)	0 (0)	0 (0)	0 (0)	0 (0)	0 (0)	0 (0)	0 (0)

Unit: mm (inches)

To calculate the installation positions

$$L (\text{minimum}) = 31.1781 (1 \frac{7}{32}) \times SS - 46.1543 (1 \frac{13}{16})$$

$$L (\text{maximum}) = 47.0644 (1 \frac{27}{32}) \times SS - 42.3308 (1 \frac{21}{32})$$

$$y = -1.463 \times x (\text{mm or inch}) + 8.0942 (5 \frac{1}{16}) \times SS$$

When using the 4:3 aspect ratio screen size

Screen Size SS (inches)		40	60	80	100	120	150	200	250	300
(mm)		1016	1524	2032	2540	3048	3810	5080	6350	7620
L	minimum	1480 (58 ³ / ₈)	2243 (88 ³ / ₈)	3006 (118 ³ / ₈)	3770 (148 ¹ / ₂)	4533 (178 ¹ / ₂)	5677 (223 ⁵ / ₈)	7585 (298 ⁵ / ₈)	9493 (373 ³ / ₄)	11401 (448 ⁷ / ₈)
	maximum	2262 (89 ¹ / ₈)	3414 (134 ¹ / ₂)	4566 (179 ⁷ / ₈)	5718 (225 ¹ / ₈)	6870 (270 ¹ / ₂)	8598 (338 ⁵ / ₈)	11478 (452)	14357 (565 ¹ / ₄)	17237 (678 ⁵ / ₈)
x		0 (0)	0 (0)	0 (0)	0 (0)	0 (0)	0 (0)	0 (0)	0 (0)	0 (0)
y		396 (15 ⁵ / ₈)	594 (23 ¹ / ₂)	792 (31 ¹ / ₄)	991 (39 ¹ / ₈)	1189 (46 ⁷ / ₈)	1486 (58 ⁵ / ₈)	1981 (78)	2477 (97 ⁵ / ₈)	2972 (117 ¹ / ₈)
x		54 (2 ¹ / ₄)	81 (3 ¹ / ₄)	108 (4 ³ / ₈)	135 (5 ³ / ₈)	163 (6 ¹ / ₂)	203 (8)	271 (10 ³ / ₄)	339 (13 ³ / ₈)	406 (16)
y		317 (12 ¹ / ₂)	475 (18 ³ / ₄)	634 (25)	792 (31 ¹ / ₄)	951 (37 ¹ / ₂)	1189 (46 ⁷ / ₈)	1585 (62 ¹ / ₂)	1981 (78)	2377 (93 ⁵ / ₈)
x		108 (4 ³ / ₈)	163 (6 ¹ / ₂)	217 (8 ⁵ / ₈)	271 (10 ³ / ₄)	325 (12 ⁷ / ₈)	406 (16)	542 (21 ³ / ₈)	677 (26 ³ / ₄)	813 (32 ¹ / ₈)
y		238 (9 ³ / ₈)	357 (14 ¹ / ₈)	475 (18 ³ / ₄)	594 (23 ¹ / ₂)	713 (28 ¹ / ₈)	892 (35 ¹ / ₈)	1189 (46 ⁷ / ₈)	1486 (58 ⁵ / ₈)	1783 (70 ¹ / ₄)
x		163 (6 ¹ / ₂)	244 (9 ⁵ / ₈)	325 (12 ⁷ / ₈)	406 (16)	488 (19 ¹ / ₄)	610 (24 ¹ / ₈)	813 (32 ¹ / ₈)	1016 (40)	1219 (48)
y		158 (6 ¹ / ₄)	238 (9 ³ / ₈)	317 (12 ¹ / ₂)	396 (15 ⁵ / ₈)	475 (18 ³ / ₄)	594 (23 ¹ / ₂)	792 (31 ¹ / ₄)	991 (39 ¹ / ₈)	1189 (46 ⁷ / ₈)
x		217 (8 ⁵ / ₈)	325 (12 ⁷ / ₈)	433 (17 ¹ / ₈)	542 (21 ³ / ₈)	650 (25 ⁵ / ₈)	813 (32 ¹ / ₈)	1084 (42 ³ / ₄)	1355 (53 ³ / ₈)	1626 (64 ¹ / ₈)
y		79 (3 ¹ / ₈)	119 (4 ³ / ₄)	158 (6 ¹ / ₄)	198 (7 ⁷ / ₈)	238 (9 ³ / ₈)	297 (11 ³ / ₄)	396 (15 ⁵ / ₈)	495 (19 ¹ / ₂)	594 (23 ¹ / ₂)
x		271 (10 ³ / ₄)	406 (16)	542 (21 ³ / ₈)	677 (26 ³ / ₄)	813 (32 ¹ / ₈)	1016 (40)	1355 (53 ³ / ₈)	1693 (66 ³ / ₄)	2032 (80)
y		0 (0)	0 (0)	0 (0)	0 (0)	0 (0)	0 (0)	0 (0)	0 (0)	0 (0)

Unit: mm (inches)

To calculate the installation positions

$$L \text{ (minimum)} = 38.1569 (1 \frac{1}{2}) \times SS - 46.1543 (1 \frac{13}{16})$$

$$L \text{ (maximum)} = 57.5992 (2 \frac{9}{32}) \times SS - 42.3308 (1 \frac{21}{32})$$

$$y = -1.463 \times x \text{ (mm or inch)} + 9.9060 (3 \frac{3}{8}) \times SS$$

2 Position the projector so that the lens is parallel to the screen.

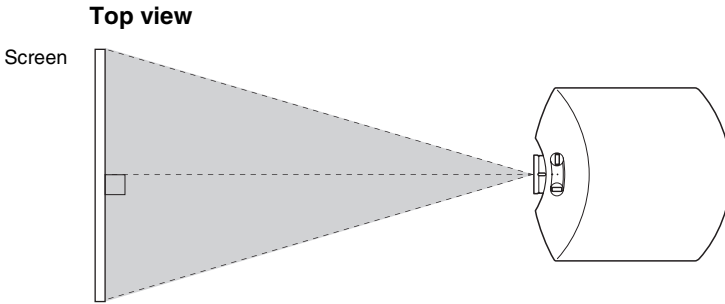

3 Project an image on the screen and adjust the picture so that it fits the screen. (☞ page 20)

Note

When using a screen with an uneven surface, stripes pattern may rarely appear on the screen depending on the distance between the screen and the projector or the zooming magnifications. This is not a malfunction of the projector.

Step 2: Adjusting the Picture Position

Project an image on the screen and then adjust the picture position.

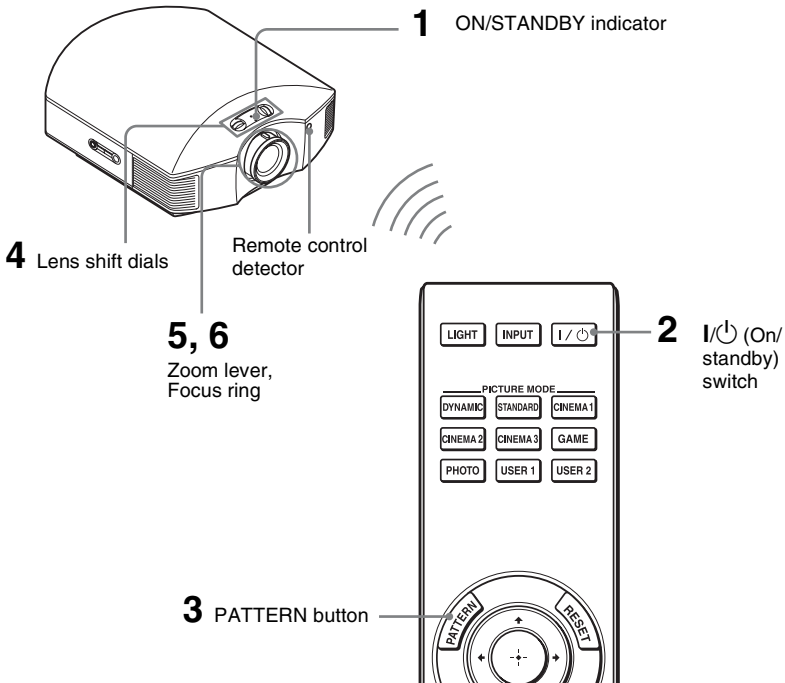

Tip

The I/⏻ (ON/STANDBY), INPUT, MENU, and ↑/↓/←/→/⊙ (joystick) buttons on the side panel of the projector function the same as those on the remote control.

Note

Depending on the installation location of the projector, you may not control it with the remote control. In this case, point the remote control to the screen instead of the projector.

ON/STANDBY



Lights in red.

1 After connecting the AC cord to the projector plug the AC cord into a wall outlet.

The ON/STANDBY indicator lights in red and the projector goes into standby mode.

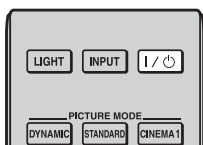

ON/STANDBY



Flashes in green for a while (tens of seconds) and then lights in green.

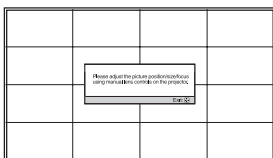
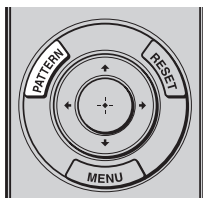

2 Press the I/⏻ (ON/STANDBY) switch to turn on the projector.

The ON/STANDBY indicator flashes in green, and then lights in green. When the ON/STANDBY indicator flashes, “Starting...” appears on the screen.

3 Display a test signal for performing adjustments.

Press the PATTERN button on the remote control to display the test signal.

Tip

The test signal is displayed for 1 minute. Press the ⊕ button to clear the test signal display before that.

4 Move both lens shift dials to adjust the picture position.

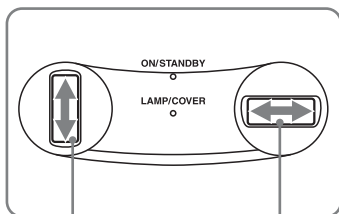

To adjust the vertical position

To adjust the horizontal position

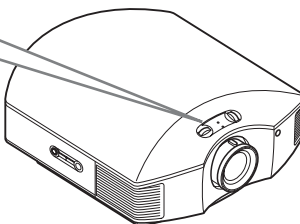



To adjust the horizontal position

Turn the lens shift dial right or left.

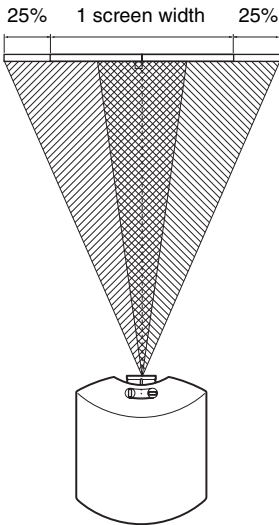
The picture projected on the screen moves right or left by a maximum of 25% of the screen width from the center of the lens.



Top view

-  : Picture position when moving the picture to the left at maximum
-  : Picture position when moving the picture to the right at maximum



To adjust the vertical position

Turn the lens shift dial up or down.

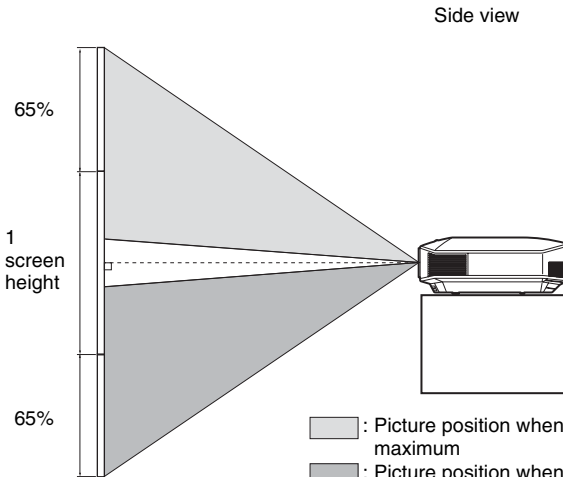
The picture projected on the screen moves up or down by a maximum of 65% of the screen height from the center of the lens.



Side view

-  : Picture position when moving the picture upward at maximum
-  : Picture position when moving the picture downward at maximum

Notes

- The range to move the picture projected on the screen can be adjusted only within the octagon area illustrated below. In this connection, see “Positioning the Projector and a screen” (📄 page 16) as well.

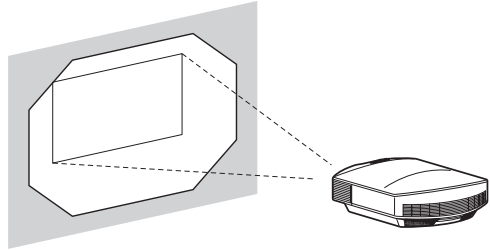
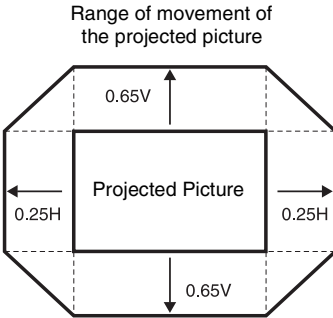

H: Width of the projected picture
V: Height of the projected picture

- When you use both the horizontal and vertical lens shift features at the same time, the distance the picture projected on the screen moves differ depending on how much the lens shift is adjusted. For details, see the table on page 17 or 18.

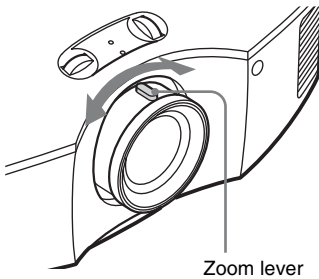

5 Adjust the picture size using the zoom lever.

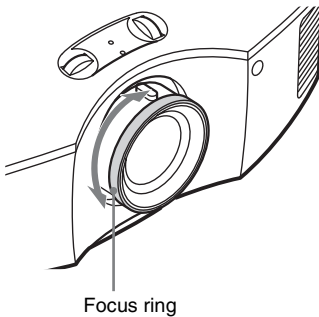

6 Adjust the focus using the focus ring.

To adjust the tilt of the installation surface

If the projector is installed on an uneven surface, use the adjusters to keep the projector level.

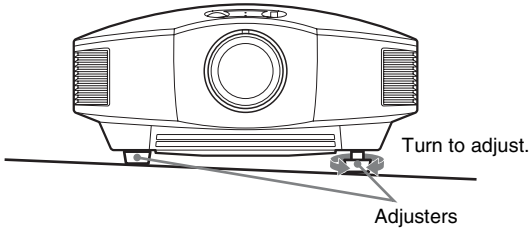

Notes

- Pointing the projector at too high or too low of a tilt will result in trapezoidal distortion in the projected image.
- Be careful not to catch your finger when turning the adjusters.

Step 3: Connecting the Projector

When making connections, be sure to do the following:

- Turn off all equipment before making any connections.
- Use the proper cables for each connection.
- Insert the cable plugs properly; poor connection at the plugs may cause a malfunction or poor picture quality. When pulling out a cable, be sure to pull it out from the plug, not the cable itself.
- Refer to the operating instructions of the connected equipment.

Connecting to a VCR

To connect to equipment with HDMI output connectors

You can enjoy better picture quality by connecting a DVD player/recorder, Blu-ray Disc player/recorder, or PS3[®] equipped with HDMI output to the HDMI input of the projector. Moreover, if you have a Control for HDMI compatible equipment, you can operate the projector synchronizing with the Control for HDMI compatible equipment. For details, see the Function  menu ([☞](#) page 55) and “About the Control for HDMI” ([☞](#) page 62).

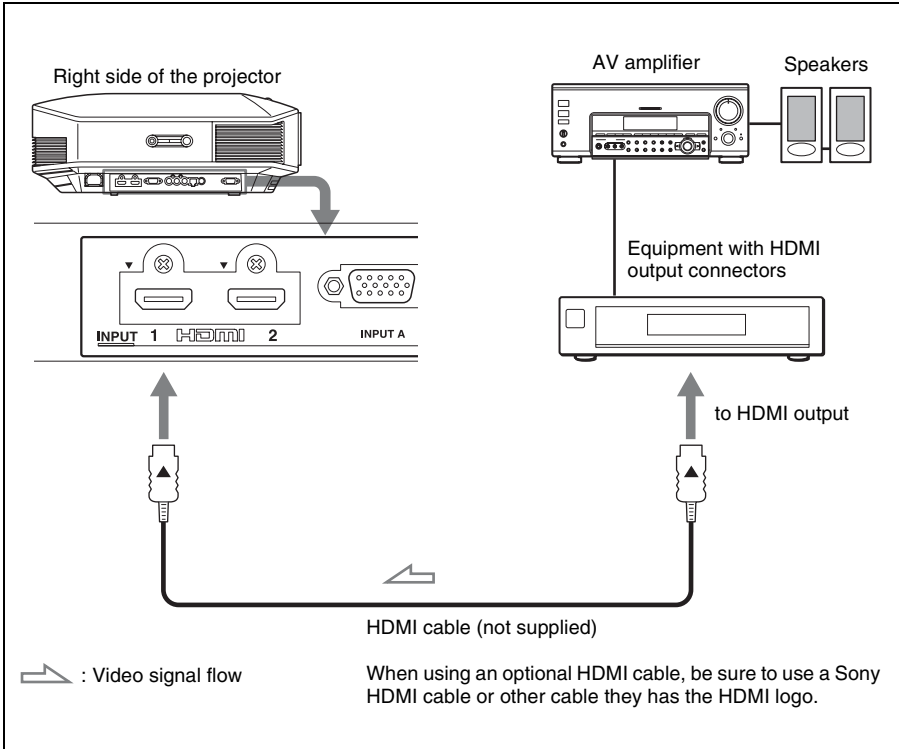

Notes

- Use a high-speed HDMI cable. With a standard HDMI cable, images of 1080p, DeepColor, and 3D video images may not be displayed properly.
- When connecting an HDMI cable to the projector, make sure the ▼ mark on the upper part of the HDMI input of the projector and the ▲ mark on the connector of the cable is set at the same position.
- If the picture from equipment connected to the projector with an HDMI cable is not clear, check the settings of the connected equipment.

To connect to equipment with component video output connectors

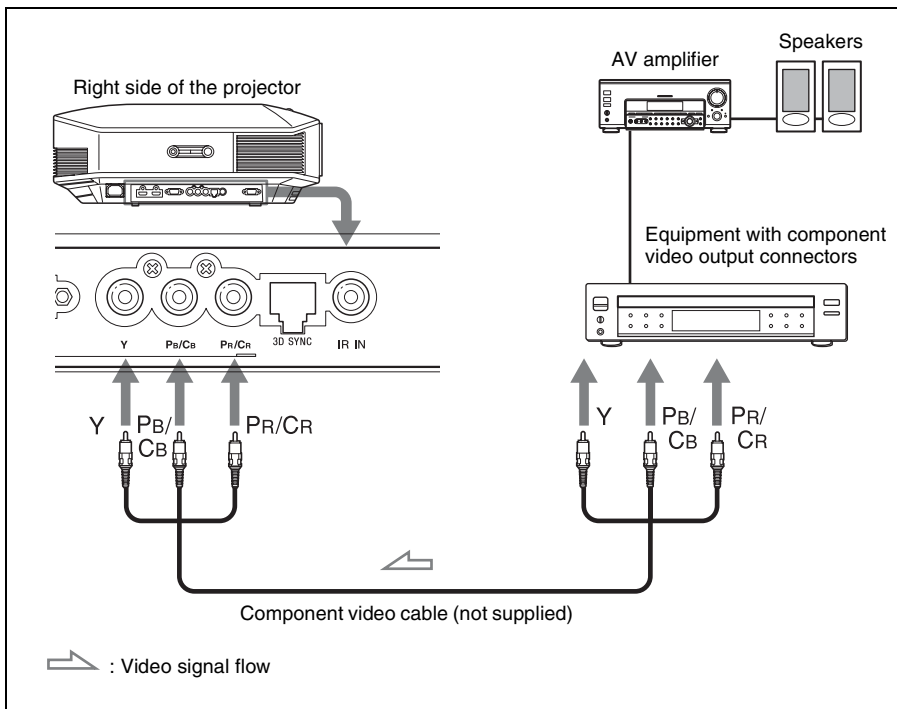

Connecting to a Computer

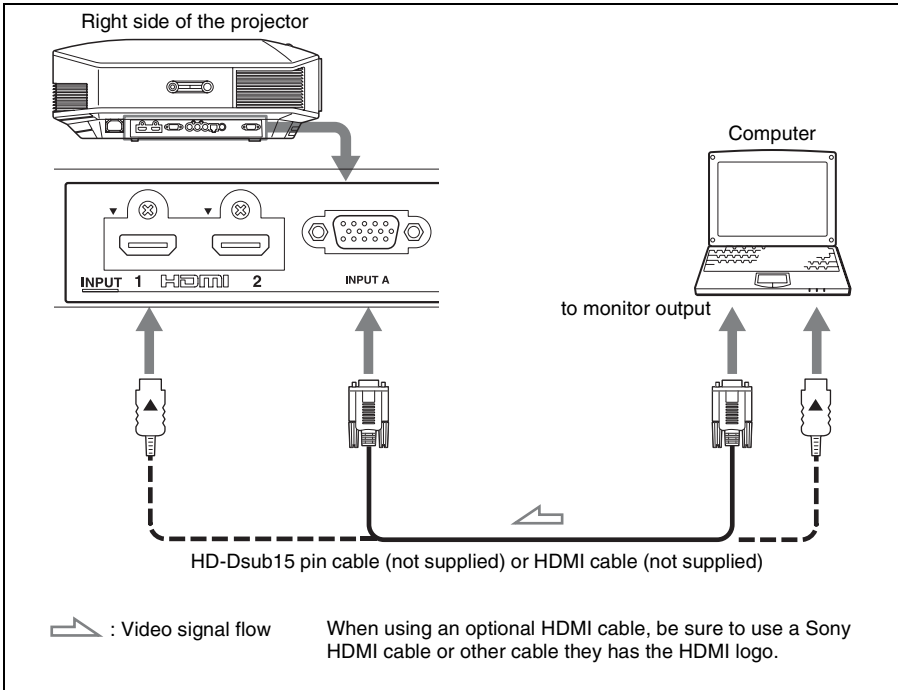

Tip

When connecting an HD-Dsub15 pin cable, set "Input-A Signal Sel." in the Setup  menu to "Auto" or "Computer." If the input signal does not appear properly, set it to "Computer." (📖 pages 54, 68)

Notes

- Use a high-speed HDMI cable. With a standard HDMI cable, images of 1080p, DeepColor, and 3D video images may not be displayed properly.
- When connecting an HDMI cable, make sure the ▼ mark on the upper part of the HDMI input of the projector and the ▲ mark on the connector of the cable is set at the same position.
- If you set your computer, such as a notebook type, to output the signal to both computer's display and this equipment, the picture of the equipment may not appear properly. Set your computer to output the signal to only the external monitor.
For details, refer to the computer's operating instructions supplied with your computer. For settings of the computer, consult with the manufacturer of the computer.
- If the picture from equipment connected to the projector with an HDMI cable is not clear, check the settings of the connected equipment.

Connecting to an Optional TMR-PJ1 3D Sync Transmitter*

The optional TMR-PJ1 3D Sync Transmitter* is required to view projected 3D video images.

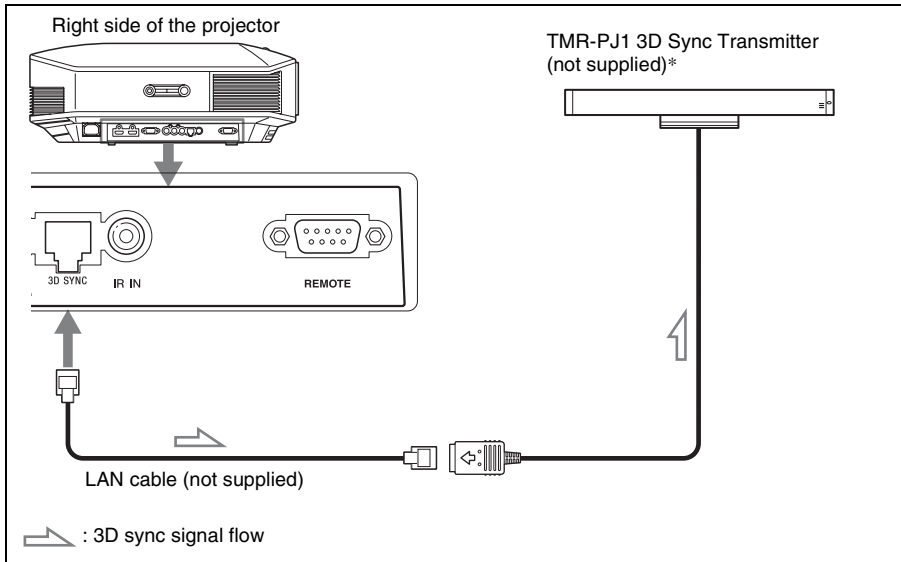

Tip

Place the optional 3D Sync Transmitter directly facing the 3D glasses. Also, in order to stabilize operation of the 3D glasses, it is recommended that you place the 3D Sync Transmitter near your viewing position.

CAUTION

Be sure to use straight-type LAN cable of up to 15 m labeled TYPE CM, and do not use an extension cord.

Notes

- Turn off the projector before connecting the 3D Sync Transmitter, otherwise the 3D Sync Transmitter is not recognized.
- The 3D SYNC connector is dedicated for the optional 3D Sync Transmitter. Do not connect computers or other network devices, to avoid malfunction.
- Be sure to use straight-type LAN cable (not supplied) labeled Cat-7 (Category 7). If you use other than the specified cable, the 3D Sync Transmitter may occasionally not work.
- Be sure to use cable of up to 15 m, and do not use an extension cord. Also, keep the LAN cable away from any AC power cords as much as possible.
- Up to one TMR-PJ1 can be connected to a projector. Never connect multiple TMR-PJ1 units, which may cause a malfunction.

* 3D Sync Transmitter is supplied with VPL-HW30AES.

Step 4: Selecting the Menu Language

You can select one of 16 languages for displaying the menu and other on-screen displays. The factory default setting is English. To change the current menu language, set the desired language with the menu screen.

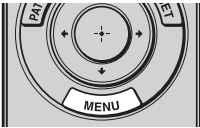
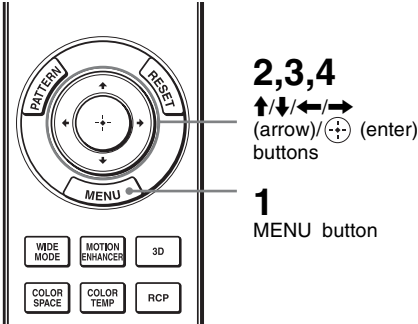

- 1 Press MENU.**
The menu appears.

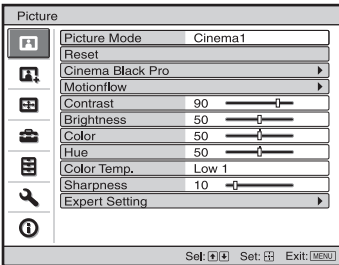

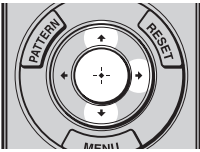

- 2** Press **↑/↓** to select the **Setup** menu, and press **→** or **⊕**.
The setting items of the selected menu appears.

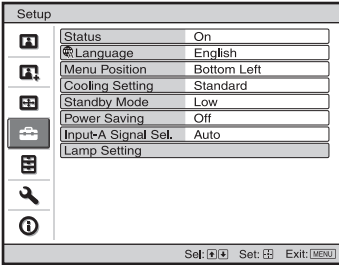

- 3** Press **↑/↓** to select “Language,” and press **→** or **⊕**.

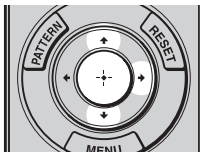

- 4** Press **↑/↓/←/→** to select a language, and press **⊕**.
The menu changes to the selected language.

To clear the menu
Press MENU.

Projecting

This section describes how to operate the projector to view the picture from the equipment connected to the projector. It also describes how to adjust the quality of the picture to suit your taste.

Projecting the Picture on the Screen

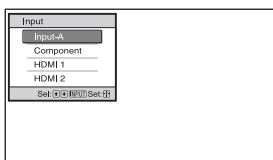
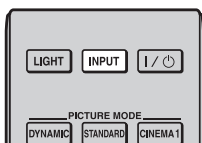

Example: To view the picture from the video equipment connected to the INPUT A connector.

- 1 Power on both the projector and the equipment connected to the projector.**
- 2 Press INPUT to display the input palette on the screen.**
- 3 Select the equipment from which you want to display images.**

Press INPUT repeatedly or press // (enter) to select the equipment from which to project.

To view the picture from	Press INPUT to display
RGB/component equipment connected to the INPUT A connector	Input-A*
Component equipment connected to the Y Pb/Cb Pr/CR connector	Component
Equipment connected to the HDMI 1 connector	HDMI 1
Equipment connected to the HDMI 2 connector	HDMI 2

* Set the “Input-A Signal Sel.” setting in the Setup menu according to the signal input. When you set it to “Auto,” and cannot display the picture properly, select an appropriate signal according to the input signal. (pages 54, 61)

Tips

- When “Auto Input Search” is set to “On” in the Function menu, only input terminals with effective signals are displayed in the input palette.
- When “Status” is set to “Off” in the Setup menu, the input palette does not appear. Press of the INPUT button to switch between input terminals in sequence.
- When the “Control for HDMI” is set to “On” in the Function menu, the input terminal with effective signals is automatically displayed, synchronizing with the operation of the equipment connected to HDMI 1 or HDMI 2 input of the projector. (Only when the connected equipment supports Control for HDMI compatible.)



Notes on input of HDMI signal

The projector adjusts the RGB dynamic range of the equipment connected with HDMI cable to the following to suit the HDMI standard and display in best picture quality.

When video signal is input: Limited (16-235)

When computer signal is input: Full (0-255)

When a signal other than those of HDMI standard is input, the following symptoms may occur.

- When a video signal is input, the color gradation of the dark area or bright area may become unclear, or texts may become faded. In this case, switch the RGB dynamic range of the connected equipment to Limited (16-235). If this adjustment is unavailable, adjust “Brightness”, “Contrast”, or “Sharpness” in the Picture  menu of the projector. (☞ page 47)
- * When a computer signal is input, the texts may become faded. In this case, adjust the “Sharpness” in the Picture  menu. (☞ page 48) (* 1,920 × 1,080 or 1,280 × 720 signals)

Turning Off the Power

1 Press the I/⏻ (ON/STANDBY) switch.

A message “POWER OFF?” appears on the screen.

2 Press the I/⏻ (ON/STANDBY) switch again before the message disappears.

The ON/STANDBY indicator flashes in green and the fan continues to run to reduce the internal heat. First, the ON/STANDBY indicator flashes quickly, during which you will not be able to light up the lamp with the I/⏻ (ON/STANDBY) switch.

Note

Never disconnect the power cord while the ON/STANDBY indicator is flashing.

The fan stops and the ON/STANDBY indicator changes from flashing green to remaining red.

The power is turned off completely, and you can disconnect the power cord.

You can turn off the projector by holding the I/⏻ (ON/STANDBY) switch for about 1 second, instead of performing the above steps.

Selecting the Wide Screen Mode

You can enjoy various wide screen modes according to the video signal received.

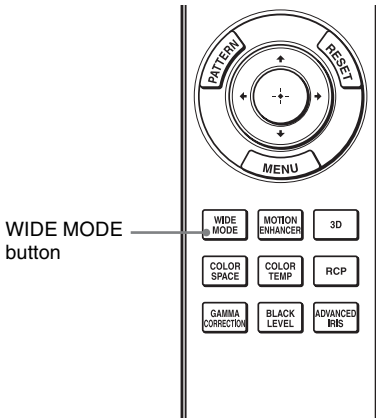

Press WIDE MODE.

Each time you press the button, you can select the “Wide Mode” setting. You can also select it using the menu. (☞ page 51)

Original image

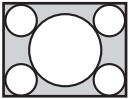

When the Wide Mode is operated

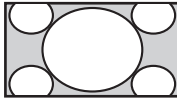

Wide Zoom (When a video signal is input)

A 4:3 aspect ratio picture is enlarged naturally to fill the screen. The upper and lower portions of the screen are slightly cut off.

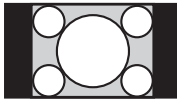
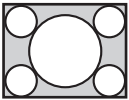

Normal (When a video signal is input)

A 4:3 aspect ratio picture is displayed in the center of the screen and enlarged to fill the screen vertically.

Squeezed

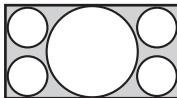
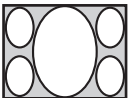

Full (When a video signal is input)

A picture squeezed to 4:3 aspect ratio is displayed in its original aspect ratio. When a 4:3 aspect ratio picture is displayed, the picture is enlarged horizontally to fill the 16:9 screen.

Tip

Squeezed: An original 16:9 aspect ratio picture is recorded horizontally compressed to a 4:3 picture.

Letterbox picture with side panels



Letterbox picture

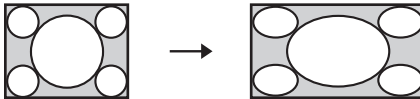
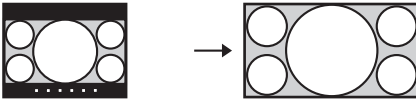

Zoom

A 16:9 aspect ratio picture is enlarged vertically and horizontally in the same ratio to fill the screen. Use this mode to view a letterbox picture or a letterbox picture with side panels.

If the subtitle of a movie, etc. is hidden and cannot be seen, adjust the screen with “Vertical Size” and “V Center” to display the subtitle. (Ⓞ page 52)

Full 1 (When a computer signal is input)

Displays a picture on the whole of the screen without changing the aspect ratio of the original picture.

Full 2 (When a computer signal is input)

Displays a picture on the whole of the screen.

Notes

- You can adjust the vertical position of the picture with “V Center” and “Vertical Size” in the Screen  menu only when “Zoom” is selected. (Ⓞ page 52)
- When the aspect ratio of the computer signal is 16:9 or wider, the “Wide Mode” setting is fixed at “Full 1.”

Notes on selecting the wide screen mode

The projector is featured with the WIDE MODE. When changing the settings of WIDE MODE, use caution as described below.

- Select the wide screen mode taking into account that changing the aspect ratio of the original picture will provide a different look from that of the original image.
- Note that if the projector is used for profit or for public viewing, modifying the original picture by switching to the wide mode may constitute an infringement of the rights of authors or producers, which are legally protected.

Watching 3D Video Images

You can enjoy powerful 3D video images, such as from 3D games and 3D Blu-ray Discs, using the optional 3D Sync Transmitter and 3D glasses*.

1 Connect the optional TMR-PJ1 3D Sync Transmitter* to the projector (☞ page 28).

2 Turn on the HDMI equipment for 3D compatibility connected to the projector then play the 3D content.

For details on how to play 3D content, refer to the operating instructions for the connected equipment.

3 Turn on the 3D glasses, after checking for comfortable fit.

For details on how to use the 3D glasses, see “Using the 3D Glasses” (☞ page 37).

4 Turn on the projector and project the 3D video image onto the screen.

For details on how to project the image, see “Projecting the Picture on the Screen” (☞ page 31).

Tips

- The factory default setting for “2D-3D Display Sel.” is “Auto.” to allow projecting 3D video images automatically when the projector detects 3D signals.
- To convert 3D video images to 2D video images, set “2D-3D Display Sel.” to “2D” (☞ page 55).

Notes

- If the 3D Sync Transmitter is not connected properly, 3D video images will not be displayed.
 - It may not be possible to display 3D video image, depending on the type of signal. Set the “3D Format” to “Side-by-Side” or “Over-Under” to suit to the 3D format in which you wish to watch the 3D content.
 - Use the 3D glasses within the communication range.
 - You can watch 3D video images only when signals from HDMI input. When connecting 3D equipment such as a 3D game or 3D Blu-ray player to the projector, use an HDMI cable.
 - There are differences in perception of 3D video images among individuals.
 - When the temperature of the usage environment is low, the 3D effect may be diminished.
- * 3D Sync Transmitter and 3D glasses are supplied with VPL-HW30AES.

Adjusting/Setting the 3D functions using the menu

Press the 3D button on the remote control to adjust the 3D settings in “3D Settings” in the Function  menu. For details, see “3D Settings” (☞ page 55).

Safety precautions

- Use only the specified 3D glasses. You should only use the 3D glasses for watching 3D video images.
- If you observe flickering or flashing, turn off the lighting in the room.
- Not for use by children without proper adult supervision.

Using the Simulated 3D Function

You can convert normal 2D video images to 3D video images.

Tip

For details on how to operate the on-screen menu, see “Operation through the Menu” (📖 page 42).

1 Display the Function  menu and select “3D Settings.”

2 Set “2D-3D Display Sel.” to “3D.”

3 Set “3D Format” to “Simulated 3D” (📖 page 55).

Tips

- Use the optional 3D glasses*.
- The projector automatically returns to 2D display and “2D-3D Display Sel.” returns to “Auto” after approximately one hour when converting 2D video images to 3D video images using the simulated 3D function.

Notes

- “2D-3D Display Sel.” cannot be set to “3D” for some video sources. For available 3D signals, see “Compatible 3D Signals” (📖 page 81).
- The simulated 3D feature may have limited effect, depending on the video source.
- There are differences in perception of 3D video images converted by the simulated 3D function among individuals.
- If the 3D Sync Transmitter is not connected properly, “3D Settings” will not be displayed in the menu.

* 3D glasses are supplied with VPL-HW30AES.

Using the 3D Glasses

Use the optional TDG-PJ1 3D glasses* to view 3D images.

Note

Connect the optional TMR-PJ1 3D Sync Transmitter* to the projector before using the 3D glasses. (☞ page 31)

* 3D Sync Transmitter and 3D glasses are supplied with VPL-HW30AES.

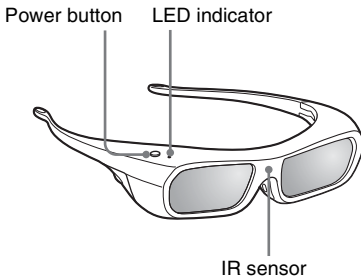

- 1** Put on the 3D glasses.
- 2** Press the power button on the 3D glasses.
The LED indicator lights up in green.
- 3** Place the 3D Sync Transmitter in view of the 3D glasses.
For detailed information, refer to the instruction manual supplied with the 3D glasses.

Precautions for use

- The 3D glasses are operated by receiving infrared signals from the 3D Sync Transmitter. Mis-operation may occur if:
 - The 3D Sync Transmitter is not facing the 3D glasses IR (infrared) sensor, or the distance between the 3D Sync Transmitter and 3D glasses is too great.
 - If there are objects blocking the path between the 3D glasses and the 3D Sync Transmitter.
 - The 3D glasses are near other infrared devices (remotely-controlled lights, air conditioners, IR transmitter).
- There are differences in perception of 3D video images among individuals.
- When the temperature of the usage environment is low, the 3D effect may be diminished.
- Be careful not to pinch your fingers in hinges of the 3D glasses when bending the temple frames.
- Do not drop or modify these 3D glasses.
- If these glasses are broken, keep broken pieces away from your mouth or eyes.
- Not for use by children without proper adult supervision.

Selecting the Picture Viewing Mode

You can select the picture viewing mode that best suits the type of program or room conditions.

The availability of each picture mode depends on whether the video image is 2D or 3D.

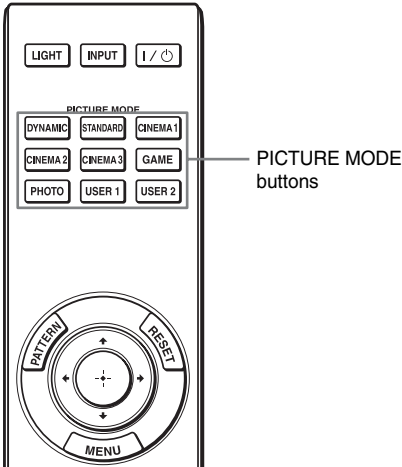

Press one of the PICTURE MODE buttons.

DYNAMIC

Project bright images with sharp, vivid picture quality.

STANDARD

Ideal for projecting TV programs, sports, concerts, and other video images.

CINEMA 1

Picture quality suited for watching movies.

CINEMA 2

Picture quality suited for digital cinema content.

CINEMA 3

Simulates production/editing studio picture quality.

GAME

Picture quality suited for playing video games.

PHOTO

Ideal for projecting still images taken with a digital camera.

USER 1, USER 2

Adjusts the picture quality to suit your taste.

Adjusting the Picture Quality

You can easily adjust the picture quality that suits your taste by selecting the adjustment items with the remote control. The adjusted data can be stored in each picture mode.

Selecting to Directly Adjust the Desired Menu Item

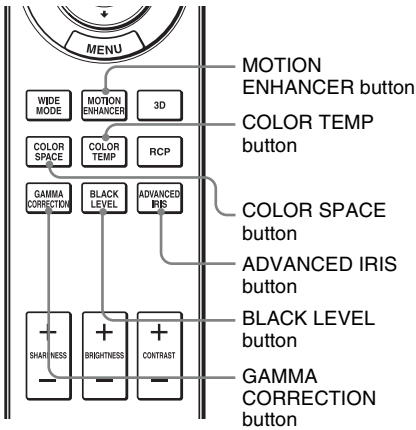

The following menu items can be adjusted by using the buttons on the remote control.

“Motion Enhancer”

“Color Temp.”

“Color Space”

“Advanced Iris”

“Black Level Adj.”

“Gamma Correction”

Press the following buttons of the desired menu item repeatedly to adjust the picture quality to suit your taste. For details on each menu item, see the Picture  menu. (🔍 page 46)

Adjusting the Picture Using Real Color Processing

The Real Color Processing (RCP) feature allows you to adjust the color, hue, and brightness of each target of the projected picture you specify independently. You can thus obtain a picture more suitable to your taste.

Tip

Freeze the scene of the video source when you are adjusting the picture using Real Color Processing.

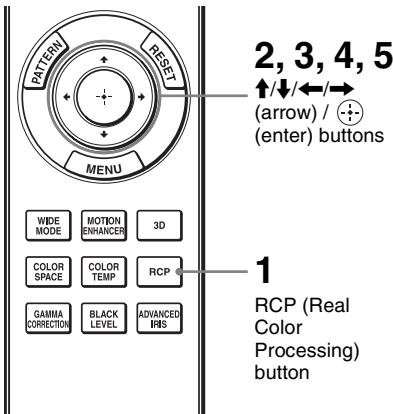

- 1 Press RCP on the remote control.**
- 2 Press \uparrow/\downarrow to select “User 1,” “User 2” or “User 3,” then press \rightarrow .**

The RCP (Real Color Processing) window appears.

- 3 Select the target color you want to adjust.**

Repeat steps **1** and **2** described below to specify the target color.

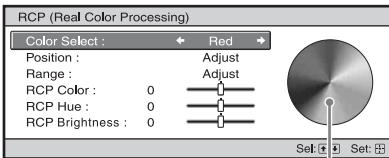

Reference palette

- 1 Press \uparrow/\downarrow to select “Color Select,” then press \leftarrow/\rightarrow to select the color you want to adjust among “Red,” “Yellow,” “Green,” “Cyan,” “Blue” and “Magenta.”**

Only the portions that correspond to the specified color will be colored and the other portions will be displayed in black and white. The reference palette in the RCP window also shows the adjustable colors. Select the desired setting to adjust the color on the projected image using the reference palette as a guide.

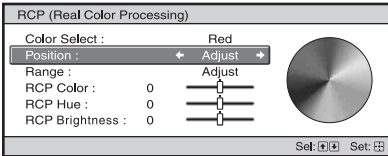

- 2 Press \uparrow/\downarrow to select “Position” or “Range,” and specify it more delicate color position and color range you want to adjust using \leftarrow/\rightarrow .

4 Adjust the color of the specified portions.

Press \uparrow/\downarrow to select “RCP Color,” “RCP Hue” or “RCP Brightness,” then adjust the color or hue of the portions selected in step 3 to suit your taste using \leftarrow/\rightarrow while watching the projected picture. The picture is returned to normal color during adjustment.

5 After the adjustment is complete, press \odot .

The RCP window disappears and the picture of step 2 is appeared. Then after a few seconds, normal picture is restored.

Tip

There are some limitations on selection of position and range.

Using the Menus

This section describes how to make various adjustments and settings using the menus.

Note

The menu displays used for the explanation may be different from the actual menu display.

Operation through the Menus

The projector is equipped with an on-screen menu for making various adjustments and settings. Some of the adjustable/setting items are displayed in a pop-up menu, in a setting menu or adjustment menu with no main menu, or in the next menu window. If you select an item name followed by an arrow (▶), the next menu window with setting items appears. To change the on-screen menu language, see “Step 4: Selecting the Menu Language.” (📖 page 29)

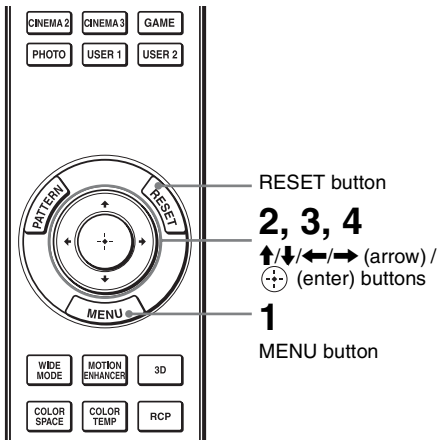

1 Press MENU.

The menu window appears.

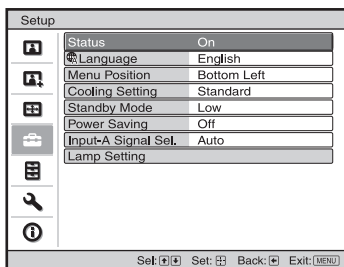
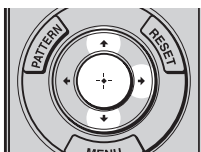
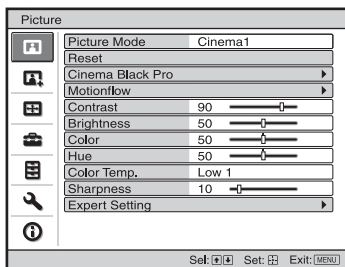
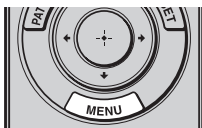

2 Press ↑/↓ to select a menu item, and press → or ⏏.

The items that can be set or adjusted with the selected menu appear. The item presently selected is shown in white.

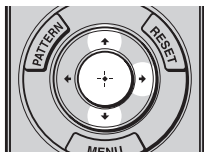

3 Press **↑/↓** to select an item you want to set or adjust and press **→** or **⊕**.

The setting items are displayed in a pop-up menu, in a setting menu, in an adjustment menu or in the next menu window.

Pop-up menu

Setting items



Setting menu

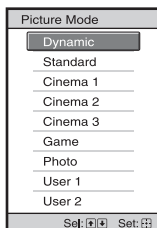

Adjustment menu

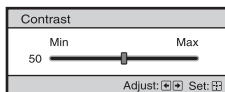

Next menu window

Setting items

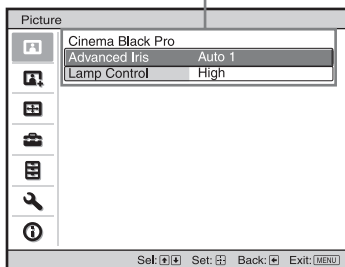

4 Make the setting or adjustment of an item.

When changing the adjustment level

To increase the value, press **↑/→**.

To decrease the value, press **↓/←**.

Press **⊕** to restore the original screen.

When changing the setting

Press **↑/↓** to change the setting.

Press **⊕** to restore the original screen.

You can restore the original menu screen using **←** depending on the selected item.

Items that cannot be adjusted

Adjustable items differ depending on the input signal. The items that cannot be adjusted or set do not appear in the menu.

(☞ page 79)

To clear the menu

Press MENU.

To reset the picture that has been adjusted

Select “Reset” from Picture  menu.

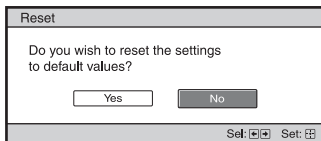

When the screen display appears, select “Yes” using **←** and press **⊕**.

All of the following settings are reset to its factory preset value.

The settings of “Cinema Black Pro”, “Motionflow”, “Contrast”, “Brightness”, “Color”, “Hue”, “Color Temp”, “Sharpness” and “Expert Setting” on the Picture  menu

To reset the items that have been adjusted

Select an item in the Menu screen, and display the pop-up menu, the setting menu, and the adjustment menu.

Press the RESET on the remote control to reset only the selected settings to its factory preset value.

Note

RESET button on the remote control is available only when the adjustment menu or the setting menu is selected.

Picture Menu

The Picture menu is used for adjusting the picture.

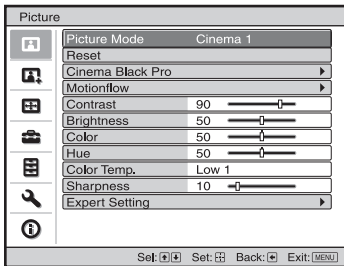



Note

These items may not be available, depending on the type of input signal. For details, see “Input Signals and Adjustable/Setting Items” (☞ page 79).

<p>Picture Mode</p>	<p>You can select the picture viewing mode that best suits the type of picture or the environment.</p> <p>The availability of each picture mode depends on whether the video image is 2D or 3D.</p> <p>Dynamic: Project bright images with sharp, vivid picture quality. Standard: Ideal for projecting TV programs, sports, concerts, and other video images. Cinema 1: Picture quality suited for watching movies. Cinema 2: Picture quality suited for digital cinema content. Cinema 3: Simulates production/editing studio picture quality. Game: Picture quality suited for playing video games. Photo: Ideal for projecting still images taken with a digital camera. User 1, User 2: You can adjust the quality of the picture to suit your taste and then store the settings. Once the settings are stored, you can view the picture with the adjusted picture quality by pressing each PICTURE MODE button on the remote control.</p> <p>Tip</p> <p>You can also store the settings if the picture quality is adjusted in other modes. To reset everything to the factory settings, select “Reset” from the menu.</p> <p>The factory default settings are as follows. User 1: Same as “Cinema 1” setting. User 2: Same as “Cinema 3” setting.</p>
<p>Reset</p>	<p>Resets all currently selected picture mode settings to their default values. (☞ page 45)</p>

Cinema Black Pro	<p>Advanced Iris Switches the iris function during projection. Auto 1: Automatically switches to an optimum iris according to a projected scene. The contrast of the scene is emphasized most. Auto 2: An optimum iris becomes smaller than when set to “Auto 1”. The contrast of the scene becomes reduced. Sensitivity: If “Auto 1” or “Auto 2” is selected, either “Recommend”, “Fast”, or “Slow” can be selected according to the desired response speed with Sensitivity Mode. Manual: Manually (fixed) adjusts the Iris.</p>  <p>Off: Disables the iris (aperture) function.</p>
	<p>Lamp Control Switches the lamp wattage during projection. High: Increases the lamp brightness, and projects brighter images. Low: Decreases the lamp brightness, and enhances blacks by minimizing brightness.</p> <p>Tip When you switch from “Low” to “High”, the number of turns of the fan increases, and the fan noise becomes slightly louder. When you switch to “Low”, energy consumption is reduced, thereby increasing the lamp life.</p>
Motionflow	<p>Motion Enhancer Reproduces fast-moving pictures smoothly without generating afterimages. High: Select this for picture quality smoother than “Low.” Low: Select this for smooth picture quality. Off: Select “Off” when noise, etc. appears in “High” or “Low.” Usually, use to set “Motion Enhancer” to “Off.”</p> <p>Note Depending on the scene, a noise in particular in digital signals may appear on the picture.</p>
Contrast	<p>Adjusts the contrast. Higher values increase the sharpness in images, while lower values decrease the sharpness. You can make adjustments by pressing CONTRAST+/- on the remote control.</p>
Brightness	<p>Adjusts the brightness of the picture. The higher the setting, the brighter the picture. The lower the setting, the darker the picture. You can make adjustments by pressing BRIGHTNESS+/- on the remote control.</p>
Color	<p>Adjusts the color density. The higher the setting, the greater the intensity. The lower the setting, the lower the intensity.</p>

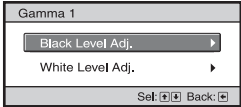
Hue	<p>Adjusts the color tone. The higher the setting, the more greenish the picture becomes. The lower the setting, the more reddish the picture becomes.</p>
Color Temp.	<p>Adjusts the color temperature. High: Equivalent to 9,300 K color temperature. Gives white colors a blue tint. Middle: Equivalent to 8,000 K color temperature. Gives a neutral tint between “High” and “Low.” Low 1: Equivalent to 6,500 K color temperature. Gives white colors a red tint. Low 2: Equivalent to 6,000 K color temperature. Gives white colors an even redder tint. Custom 1 to 5: Enables you to adjust, set, and store your favorite color temperature. The factory default settings are as follows. Custom 1: Same as “High” color temperature setting. Custom 2: Same as “Middle” color temperature setting. Custom 3: Same as “Low 1” color temperature setting. Custom 4: Same as “Low 2” color temperature setting. Custom 5: Setting that prioritizes brightness.</p>
Sharpness	<p>Sharpens the outline of the picture, or reduces the noise. The higher the setting, the sharper the picture. The lower the setting, the softer the picture, thus reducing the noise. You can make adjustments by pressing SHARPNESS+/- on the remote control.</p>
Expert Setting	<p>NR (Noise Reduction) Reduces the roughness or noise of the picture. Usually, select “Off”. If the picture is rough or noisy, select a setting from among “Low”, “Middle” or “High” according to the input signal source.</p> <p>MPEG NR (MPEG Noise Reduction) Reduces block noise and mosquito noise, in particular in digital signals. Block NR: Reduces digital noise that appears in mosaic-like pattern. Mosquito NR: Reduces digital noise that appears near the outline of the picture.</p> <p>Film Mode According to the film source you have selected, make a setting for playback. Auto 1: Suited for reproducing a picture movement close to the original picture movement of the film source. Normally, set this to “Auto 1.” Auto 2: Reproduces a 2-3 or 2-2 Pull-Down format video signal, such as film sources, in a smooth picture movement. When a video signal other than 2-3 or 2-2 Pull-Down format is input, the picture is played back in progressive format. Off: Plays back the picture in progressive format without detecting video signals automatically.</p>

<p>Expert Setting</p>	<p>Gamma Correction Adjusts the response characteristics of the tone of the picture. Select a favorite tone from 8 options. Gamma 1: Bright Produces a brighter picture overall. Gamma 2: ↑ Off ↓ Gamma 3: Dark Produces a darker picture overall. Gamma 4: Brightens dark areas in the picture, and expands gradation expression. Gamma 5: Produces a picture with contrast emphasized slightly. Gamma 6: Produces a picture with contrast emphasized more than with Gamma 5. Gamma 7: Simulates the gamma curve of film. Gamma 8: Simulates the gamma curve of still image. Off: Gamma Correction is “Off.”</p> <div style="text-align: center; border: 1px solid black; padding: 5px; width: fit-content; margin: 10px auto;">  </div> <p>Black Level Adj. (Adjust): Produces a bolder, dynamic picture. Set according to the input signal source. 3: Brightens dark areas in the picture, and expands gradation. ↑ -3: Emphasizes dark areas in the picture.</p> <div style="text-align: center; border: 1px solid black; padding: 5px; width: fit-content; margin: 10px auto;">  </div> <p>White Level Adj. (Adjust): Produces clear picture with sharp light/dark contrast. Set according to the input signal source. 3: Makes bright areas in the picture even brighter. ↑ -3: Lowers the brilliance of bright areas in the picture.</p> <p>x.v.Color Set this item when playing back an x.v.Color video signal. Set this item to “On” when connecting the projector with equipment that supports x.v.Color and playing back an x.v.Color video signal. For details on x.v.Color, see “About the x.v.Color” (📖 page 62).</p> <p>Color Space You can convert the range of color reproduction. Normal: Color range conforming to sRGB standards. Wide 1: Reproduces color similar to film. Wide 2: Reproduces color similar to digital cinema. Wide 3: Produces a wider, more vivid range of color reproduction.</p>
------------------------------	---

Advanced Picture Menu

The Advanced Picture is used for adjusting the picture more.

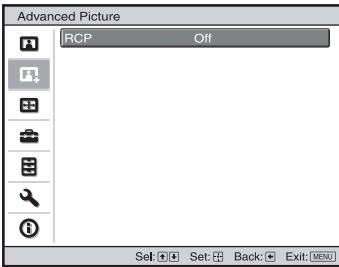

RCP (Real Color Processing)

You can adjust the color, hue, and brightness of each selected portion of the picture independently.

User 1, User 2, User 3: You can adjust the picture using Real Color Processing and store the settings. Once the settings are stored, you can view the picture with the adjusted picture quality.

Off: Cancels this feature.

For details, see “Adjusting the Picture Using Real Color Processing”.
( page 40)

Screen Menu



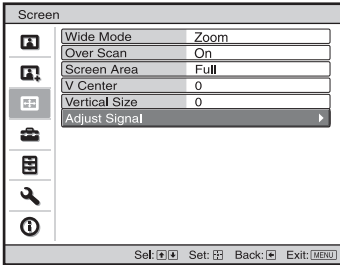



The Screen menu is used to adjust the input signal. You can adjust the size of the picture, and select wide screen mode, etc.



Note

These items may not be available, depending on the type of input signal. For details, see “Input Signals and Adjustable/Setting Items” (page 79).

<p>Wide Mode (Video signal)</p>	<p>You can set the aspect ratio of the picture to be displayed for the current input signal. (page 33) This item is enabled only when a video signal (preset memory numbers 3 to 14) (page 77) is input.</p> <p>Wide Zoom: A 4:3 aspect ratio picture is enlarged naturally to fill the screen. The upper and lower portions of the screen are slightly cut off.</p> <p>Normal: A 4:3 aspect ratio picture is displayed in the center of the screen and enlarged to fill the screen vertically.</p> <p>Full: A picture squeezed to 4:3 aspect ratio is displayed in its original aspect ratio. When a 4:3 aspect ratio picture is displayed, the picture is enlarged horizontally to fill the 16:9 screen.</p> <p>Zoom: A 16:9 aspect ratio picture is enlarged vertically and horizontally in the same ratio to fill the screen. The upper and lower portions are cropped.</p> <p>You can switch settings by pressing WIDE MODE on the remote control.</p>
<p>Wide Mode (Computer signal)</p>	<p>You can set the aspect ratio of the picture to be displayed for the current input signal. (page 34) This item is enabled only when a computer signal is input.</p> <p>Full 1: Displays a picture on the whole of the screen without changing the aspect ratio of the original picture.</p> <p>Full 2: Displays a picture on the whole of the screen.</p> <p>Zoom: A picture is enlarged vertically and horizontally in the same ratio to fill the screen. The upper and lower portions are cropped.</p> <p>You can switch settings by pressing WIDE MODE on the remote control.</p> <p>Note</p> <p>When the aspect ratio of the input signal is 16:9 or wider, this setting is fixed at “Full 1”.</p>

Over Scan	<p>Hides the outline of the picture.</p> <p>On: Hides the outline of the input picture. Select this setting when noise appears along the edge of the picture.</p> <p>Off: Projects the whole of the input picture.</p> <p>Tip</p> <p>To display the displayable region within the four directions of the screen, refer to “Blanking” on the Installation  menu ( page 58).</p>
Screen Area	<p>Selects the size of the picture when a Hi-Vision picture is overscanned.</p> <p>Full: Expands the picture on the whole of the screen.</p> <p>Through: Does not expand the picture on the whole of the screen.</p>
V Center	<p>Adjust the whole picture by moving up and down on the screen.</p> <p>As the selected number increases, the screen moves up, and as the selected number decreases, the screen moves down.</p>
Vertical Size	<p>Reduces or enlarges the picture vertically.</p> <p>The screen is enlarged as the setting increases and reduced as the setting decreases. If the subtitle of a movie, etc. cannot be seen, use this together with “V Center”.</p>
Adjust Signal	<p>You can adjust the input signal.</p> <p>APA: Adjusts “Phase”, “Pitch”, and “Shift” automatically to a position that suits the image signal for pictures from a computer.</p> <p>Phase: Adjusts the dot phase and the phase of computer signal of pictures from a computer. Adjusts the picture to the point where it looks clearest.</p> <p>Pitch: Adjusts the horizontal size of the picture from a computer. As the number increases, the picture becomes wider, and as the number decreases, the picture becomes narrower. Adjust the setting to match the number of dots of the input signal.</p> <p>Shift: Adjusts the position of the picture.</p> <p>H: As the setting for H (horizontal) increases, the picture moves to the right, and as the setting decreases, the picture moves to the left. Use  /  to adjust the horizontal position.</p> <p>V: As the setting for V (vertical) increases, the picture moves up, and as the setting decreases, the picture moves down. Use  /  to adjust the vertical position.</p>

Setup Menu

The Setup menu is used to change the factory preset settings, etc.

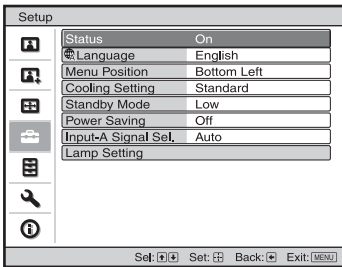

Status	<p>Sets whether or not the on-screen display is displayed. Set to “Off” to turn off the on-screen displays except for certain menus, message when turning off the power, and warning messages.</p>
Language	<p>Selects the language used in the menu and on-screen displays. Available languages are: English, Dutch, French, Italian, German, Spanish, Portuguese, Russian, Swedish, Norwegian, Japanese, Chinese (Simplified Chinese), Chinese (Traditional Chinese), Korean, Thai and Arabic.</p>
Menu Position	<p>You can change the position to display the menu on the upper screen. Bottom Left: Displays the menu on the bottom left area of the screen. Center: Displays the menu on the center of the screen.</p>
Cooling Setting	<p>Use this item when using the projector at high altitudes. High: Use this setting when using the projector at an altitude of 1,500 m or higher. Standard: Use this setting when using the projector at normal altitudes.</p> <p>Notes</p> <ul style="list-style-type: none"> When this item is set to “High”, the fan noise becomes slightly louder since the number of fan rotations increase. Do not use the projector at an altitude of 2,700 m or higher.
Standby Mode	<p>Lowers the power consumption in standby. When set to “Standard”, the power consumption in standby becomes normal. When set to “Low”, the power consumption in standby is lowered.</p> <p>Notes</p> <ul style="list-style-type: none"> The factory default setting is “Low”. When this item is set to “Low”, the “PJ Auto Power On” function is disabled (The function is set to “Off” and does not appear in the menu.).(ⓘ page 56)

Power Saving	<p>Sets the power saving mode.</p> <p>When set to “On”, the projector goes into power saving mode if no signal is input for 10 minutes. At that time, the ON/STANDBY indicator lights in orange, then the screen becomes dark. In power saving mode, the power saving mode is cancelled if a signal is input or any button on the projector or the remote control is pressed. If you do not want to set the projector to power saving mode, select “Off”.</p>
Input-A Signal Sel.	<p>Selects the type of signal input from the equipment connected to the INPUT A connector.</p> <p>Selects the type of signal input from the equipment by selecting “Input-A” with the INPUT button.</p> <p>Auto: Selects the input signal type automatically.</p> <p>Computer: Inputs the signal from a computer.</p> <p>Video GBR: Inputs the signal from a TV game or HDTV broadcast.</p> <p>Component: Inputs the component signal from a DVD player/recorder, Blu-ray Disc player/recorder, digital tuner, etc.</p> <p>Note</p> <p>When the input signal is not displayed correctly with this item set to “Auto,” select the item according to the input signal.</p>
Lamp Setting	<p>When replacing the lamps, set the desired lamp setting.</p> <p>(☞ page 71)</p>

Function Menu

The Function menu is used for changing the settings of the various functions of the projector.

The 3D Settings menu can be displayed by pressing the 3D button on the remote control.

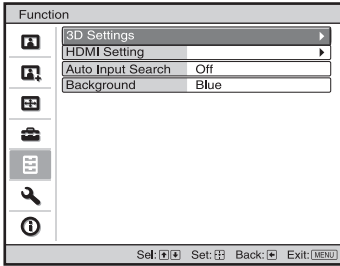

<h3>3D Settings</h3>	<p>You can change the settings of the 3D function.</p> <p>2D-3D Display Sel.: For Switching the video images to “2D” or “3D.”</p> <p>Auto: Displays 3D video images when HDMI signals with 3D information are input. Displays 2D video images when other signals are input.</p> <p>3D: Displays 3D video images according to the 3D system selected in “3D Format.” However, when HDMI signals with 3D information are input the projector, displays 3D video images according to the 3D system of the HDMI signals with 3D information.</p> <p>2D: Displays 2D video images.</p> <p>* The 3D information is additional information to discriminate 3D.</p> <p>3D Format: You can select this item by pressing ▶ on the remote control when setting “2D-3D Display Sel.” to “3D.” Set the 3D system when the input HDMI signals do not include 3D information.</p> <p>Simulated 3D: Converts 2D video images to 3D video images. The setting can be made only for input the HD signals.</p> <ul style="list-style-type: none"> • The simulated 3D feature may have limited effect, depending on the video source. • There are differences in perception of 3D video images among individuals. • The projector automatically returns to 2D display after approximately one hour when displaying the 3D video images with simulated 3D. <p>Side-by-Side: Displays 3D images as received (before conversion to sequential) in left-right split-screen format.</p> <p>Over-Under: Displays 3D images as received (before conversion to sequential) in top-bottom split-screen format.</p>
----------------------	--





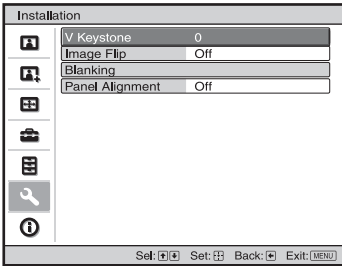

<p>3D Settings</p>	<p>3D Glasses Bri'ness: For adjusting the brightness of the picture when watching 3D video images using the 3D glasses. You can select the brightness from among “Min,” “1,” “2,” “3,” and “Max.”</p> <p>3D Depth Adjust: For adjusting the depth of the 3D video images on the screen. The setting can be made only when a 3D Format other than “Simulated 3D” is selected.</p> <p style="text-align: center;"> Depth -2 -1 0 +1 +2 Front ← Normal → Depth </p> <p>We recommended that “3D Depth Adjust” be set to “0.” The 3D video images may be difficult to perceive, depending on the setting of “3D Depth Adjust.”</p> <p>Simulated 3D Effect: For adjusting the 3D effect when 2D content is converted to 3D video images. You can select the effect from among “High,” “Middle,” and “Low.”</p> <p>Notes</p> <ul style="list-style-type: none"> • “3D Settings” will not be displayed if the 3D Sync Transmitter is not connected before turning on the projector. • The menu display has a ghost while a 3D video image is displayed and is best viewed with the 3D glasses. • We recommended that the screen size be 100 to 120 inches. If you watch 3D video images on a screen larger than 100 inches, the 3D effect may be diminished.
<p>HDMI Setting</p>	<p>You can change the settings of the Control for HDMI function.</p> <p>Control for HDMI: Selects the function whether to turn the Control for HDMI function effective when the HDMI 1 and HDMI 2 connectors are connected to a Control for HDMI compatible equipment.</p> <p>When set to “On”, the following are available.</p> <ul style="list-style-type: none"> • The operation of the projector and the connected Control for HDMI compatible equipment will synchronize with each other. • The Control for HDMI setting of Sony equipment (AV amplifier, video, etc.), which is compatible with “Control for HDMI - Easy Setting”*, will also be effective. <p>The factory default setting is “On”.</p> <p>Device Auto Power Off: Sets whether to also turn the power of the connected Control for HDMI compatible equipment off when you turn the power of the projector off.</p> <p>When set to “On”, the equipment will synchronize and turn off when the power of the projector turns off.</p> <p>The factory default setting is “On”.</p> <p>PJ Auto Power On: Select whether to link the power of the projector to the Control for HDMI compatible equipment.</p> <p>When set to “On”, the power of the projector will automatically turn on when the power of the connected equipment is turned on or when making operations such as playback.</p> <p>Note</p> <p>To enable this function, set “Standby Mode” (ⓘ page 53) in the Setup  menu to “Standard”, and then set “PJ Auto Power On” to “On”. For details, see “About the Control for HDMI” (ⓘ page 62).</p>

HDMI Setting	<p>Device List: Lists all the Control for HDMI compatible equipment connected to the projector.</p> <p>When “Enable” is selected, the Control for HDMI setting of Sony equipment (AV amplifier, video, etc.), which is compatible with “Control for HDMI - Easy Setting”, will also be effective.</p> <div data-bbox="479 252 893 628" style="border: 1px solid black; padding: 5px; margin: 10px auto; width: fit-content;"> <table border="1" style="width: 100%; border-collapse: collapse;"> <thead> <tr> <th style="text-align: left;">Input</th> <th style="text-align: left;">Device</th> <th style="text-align: left;">Type</th> </tr> </thead> <tbody> <tr> <td>HDMI 1</td> <td>Player 1</td> <td>BD</td> </tr> <tr> <td>HDMI 2</td> <td>Player 2</td> <td>DVD</td> </tr> </tbody> </table> <p style="font-size: small; margin-top: 10px;">Would you like to enable for HDMI settings for connected devices? Before enabling settings, turn on the devices. For unrecognized devices, check settings on their side.</p> <p style="text-align: center; margin-top: 5px;"><input type="button" value="Enable"/></p> <p style="text-align: right; font-size: x-small; margin-top: 5px;">Set: [] Back: [MENU]</p> </div> <p>* “Control for HDMI - Easy Setting” is a function that makes the Control for HDMI setting of equipment connected to HDMI input of the projector effective as well when the Control for HDMI setting of the projector is effective. This function is only available between compatible Sony equipment, and some equipment may not be compatible.</p> <p>Although some non-Sony equipment may be compatible, operation is not guaranteed for such equipment.</p>	Input	Device	Type	HDMI 1	Player 1	BD	HDMI 2	Player 2	DVD
Input	Device	Type								
HDMI 1	Player 1	BD								
HDMI 2	Player 2	DVD								
Auto Input Search	<p>Hides input terminals that do not have signal input.</p> <p>When set to “On”, terminals without input signals do not appear on the input palette that appears when you press INPUT.</p> <p>To display all input terminals, set this to “Off”. (Ⓞ page 31)</p>									
Background	<p>Selects the background color of the screen when no signal is input.</p> <p>You can select “Black” or “Blue”.</p>									

Installation Menu

The Installation menu is used for changing the installation settings.



<p>V Keystone</p>	<p>Corrects the vertical trapezoidal distortion of the picture. When the bottom of the trapezoid is longer than the top (): Sets a lower value (– direction) When the top of the trapezoid is longer than the bottom (): Sets a higher value (+ direction).</p> <p>Note</p> <p>Depending on the picture position adjusted with the lens shift feature, the aspect ratio of the picture may change from the original or picture distortion may occur with V Keystone adjustment.</p>
<p>Image Flip</p>	<p>Flips the picture on the screen horizontally and/or vertically. Off: The picture does not flip. HV: Flips the picture horizontally and vertically. H: Flips the picture horizontally. V: Flips the picture vertically. Use this item for installation for the backside projection or ceiling installation.</p>
<p>Blanking</p>	<p>This feature allows you to adjust the displayable region within the four directions of the screen. Select the edge to adjust by highlighting Left, Right, Top, or Bottom using the  /  buttons. Adjust the amount of blanking using the  /  buttons.</p> <div data-bbox="549 1193 822 1353" data-label="Image"> <p>The screenshot shows a menu titled "Blanking" with four input fields:</p> <ul style="list-style-type: none"> Left: 2 Right: 3 Top: 2 Bottom: 3 <p>At the bottom, there are control buttons: Set, Adjust, and Set.</p> </div> <p>Note</p> <p>When both the “Blanking” and the “V Keystone” are adjusted at the same time, the “Blanking” cannot be adjusted correctly. When using the “Blanking”, make sure that you set the “V Keystone” to “0”.</p>

Panel Alignment

This feature allows you to adjust the gaps in the color of characters or the picture.

When set to “On”, the “Adjust Color” and the “Pattern Color” can be assigned and adjusted.

Adjust Color: Assigns the desired color to adjust the gaps in color. Select “R” (Red) or “B” (Blue) to make adjustments based on “G” (Green).

Pattern Color: Select “R/G” (Red and Green) or “R/G/B” (White, all colors) when the “Adjust Color” is “R” (Red). Select “B/G” (Blue and Green) or “R/G/B” (White, all colors) only when the “Adjust Color” is “B” (Blue).

Adjust: Assign the settings of the horizontal direction (H) with ← / → buttons and the vertical direction (V) with ↑ / ↓ buttons on the Shift Adjust screen. The colors selected in the “Adjust Color” can be adjusted with the ← / →, ↑ / ↓ buttons in each direction.

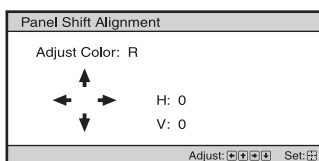

Reset: Returns to the factory settings.

Note

Depending on the adjustments made above, the number of display pixel may decrease. Also, colors may become uneven or the resolution may change.

Tip

If colors appear on the edge of the screen after making the adjustments above, adjust the region of the picture to display with “Blanking” in the Installation  menu. (Ⓞ page 58)

Information Menu

The Information menu displays the model name, serial number, the horizontal and vertical frequencies of the input signal and the cumulated hours of usage of the lamp.

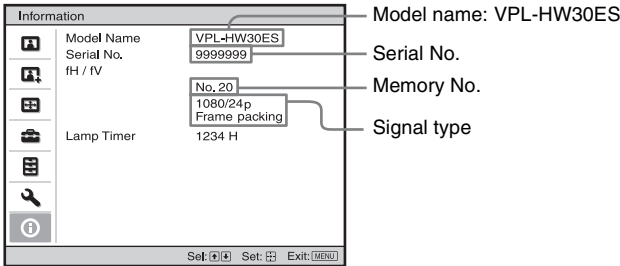



Model name	Displays the model name (VPL-HW30ES).
Serial No.	Displays the serial number.
fH (horizontal frequency)	Displays the horizontal frequency of the input signal.
fV (vertical frequency)	Displays the vertical frequency of the input signal.
Memory No.	Displays the preset memory number of the input signal.
Signal type	Displays the type of the input signal. When input signals with 3D information are input, the type of input signals and the 3D format are displayed.
Lamp Timer	Indicates how long the lamp has been turned on (total usage).

Notes

- fH (horizontal frequency) and fV (vertical frequency) may not be displayed depending on the input signal used on the projector.
- You cannot change the displays listed above.

About the Preset Memory No.

This projector has 32 types of preset data for input signals (the preset memory). When the preset signal is input, the projector automatically detects the signal type and recalls the data for the signal from the preset memory to adjust it to an optimum picture. The memory number and signal type of that signal are displayed in the Information  menu.

You can also adjust the preset data through the Screen  menu.

This projector also contains 20 different user memories beside the preset memories used for inputting analog computer signals. You can save input signals that have not been preset on these user memories.

When an unpreset signal is input for the first time, a memory number is displayed as 0.

When you adjust the data of the signal in the Screen  menu, it will be registered to the projector. If more than 20 user memories are registered, the newest memory always overwrites the oldest one.

See the chart on page 77 to find if the signal is registered to the preset memory.

Note

When the aspect ratio of input signal does not match the screen size, a part of the screen is displayed in black.

Others

This section describes about the other functions, how to solve the problems, how to replace the lamp and air filter, etc.

About the Control for HDMI

What is the Control for HDMI?

Control for HDMI is an HDMI standard mutual control function which uses the HDMI CEC (Consumer Electronics Control) specification. By connecting a variety of Control for HDMI compatible equipment such as a hard disk Blu-ray Disc player, a DVD player/recorder, an AV amplifier, etc. to a Control for HDMI compatible TV or a projector with an HDMI cable, the equipment connected will synchronize with the TV or the projector when either is operated.

Using the Control for HDMI function

- Connect and assign the settings of each equipment appropriately.
- Do not turn off the main power of the equipment.
- Set the input setting of the projector to the HDMI input which the equipment is connected.
- Check if the picture from the equipment appears appropriately on the projector.

Connecting a Control for HDMI compatible equipment

Use an HDMI cable to connect the projector and the Control for HDMI compatible equipment. Use a cable that has acquired the HDMI logo.

Setting the Control for HDMI

Be sure to assign the appropriate connections for both the projector and the Control for HDMI compatible equipment

connected to the projector. For settings of the projector, see page 56. For settings of the Control for HDMI compatible equipment connected to the projector, refer to its operational instructions. When equipment that is compatible with the “Control for HDMI - Easy Setting” is connected to the HDMI input of the projector, if you turn the Control for HDMI function setting of the projector on, the Control for HDMI function setting of the connected equipment will also turn on.

What you can do with the Control for HDMI

- By turning on or playing back the connected equipment, the projector will turn on and the input setting will switch to the terminal of the connected equipment automatically.
- By turning the power of the projector off, the power of the connected equipment will also turn off automatically.
- By changing the language setting of the projector, the language setting of the connected equipment will also change to the same language automatically.

Notes

- The available functions of the Control for HDMI differ depending on each equipment. Refer to the operating instruction of each equipment.
- Some synchronization may be available with equipment of other brands with similar functions, but it is not guaranteed.

About the x.v.Color

- “x.v.Color” is a promotion name given to the products that have the capability to realize a wide color space based on the

xvYCC specifications and is a trademark of Sony Corporation.

- xvYCC is an international standard of the technical specifications of the extended-gamut color space for video signals. The color gamut of xvYCC is wider than the one of sRGB that is used with the current television system.

About the simulated 3D feature

- Use the simulated 3D function taking into account that the picture will provide a different look from the original images, because this function converts the video images.
- Note that if the projector is used for profit or for public viewing, displaying 2D video images as 3D video images by converting to the simulated 3D may constitute an infringement of the rights of authors or producers, which are legally protected.





Troubleshooting



If the projector appears to be operating erratically, try to diagnose and correct the problem using the following instructions. If the problem persists, consult with qualified Sony personnel.

Power



Symptom	Cause and Remedy
The power is not turned on.	<ul style="list-style-type: none"> → The power may not turn on if you turn the power off with I/⏻ (ON/STANDBY) switch and turn it on again in a short time. After about 1 minute, turn the power on. → Close the lamp cover securely, then tighten the screws securely. (☞ page 70) → Close the filter holder securely. (☞ page 71) → Check warning indicators. (☞ page 67)

Picture

Symptom	Cause and Remedy
No picture.	<ul style="list-style-type: none"> → Check that the proper connections have been made. (☞ page 25) → Select the input source correctly using the INPUT button. (☞ page 31) → Set the computer signal to output from an external monitor. → Set the computer signal to output only to an external monitor. → Select “Computer,” “Component” or “Video GBR” for “Input-A Signal Sel.” on the Setup  menu according to the input signal. (☞ page 54)
The picture from the INPUT A connector is colored strange.	<ul style="list-style-type: none"> → Select “Computer,” “Component” or “Video GBR” for “Input-A Signal Sel.” on the Setup  menu according to the input signal. (☞ page 54)
The picture has ghosts.	<ul style="list-style-type: none"> → Video images are displayed in 3D. Watch the 3D video images using the 3D glasses, or set “2D-3D Display Sel.” to “2D” (☞ page 55).
The bright area of the picture may become unclear or texts may become faded. (When HDMI video signal is input)	<ul style="list-style-type: none"> → This symptom may occur when a signal other than those of HDMI standard is input. (☞ page 32) Switch the RGB dynamic range of the connected equipment to Limited (16-235). If this adjustment is unavailable, adjust “Brightness”, “Contrast”, or “Sharpness” in the Picture  menu of the projector. (☞ page 47)
The texts may become faded when connected with a computer. (When computer signal is input)	<ul style="list-style-type: none"> → This symptom may occur when a signal other than those of HDMI standard is input. (☞ page 32) Adjust “Sharpness” in the Picture  menu. (☞ page 47)
The picture is too dark.	<ul style="list-style-type: none"> → Adjust the “Contrast” or “Brightness” of the Picture  menu properly. (☞ page 47)

Symptom	Cause and Remedy
The picture is not clear.	<ul style="list-style-type: none"> → Adjust the focus. (☞ page 23) → Condensation has accumulated on the lens. Leave the projector for about 2 hours with the power on.
The picture flickers.	<ul style="list-style-type: none"> → For pictures from a computer, activate “APA” and adjust the current input signal. → Adjust “Phase” for “Adjust Signal” in the Screen  menu properly. (☞ page 52)
The color of characters or the picture is not appropriate.	<ul style="list-style-type: none"> → Select the desired color registration in “Panel Alignment” of Installation  menu (☞ page 59).
Image is left on the screen. (image retention)	<ul style="list-style-type: none"> → When High contrast non-moving images are displayed for a long period of time, there may be some image retention on the screen. This is only a temporary condition. Turning off the power for a while will eliminate the retained image.

On-screen display

Symptom	Cause and Remedy
On-screen display does not appear.	<ul style="list-style-type: none"> → Set “Status” in the Setup  menu to “On.” (☞ page 53) → Check if the ON/STANDBY indicator should light in green. The ON/STANDBY indicator flashes while the projector is starting up. Avoid using the projector until the indicator light up in green.
The model name does not disappear from the screen. Or else, the demo mode is displayed continuously.	<ul style="list-style-type: none"> → The display mode of the projector may be set at the time of purchase. Consult with your local dealer or qualified Sony personnel.
Input terminals do not appear.	<ul style="list-style-type: none"> → Set “Auto Input Search” in the Function  menu to “Off”. (☞ page 57)

Remote control

Symptom	Cause and Remedy
The remote control does not work.	<ul style="list-style-type: none"> → Batteries could be weak. Replace them with new batteries. (☞ page 11) → Insert the batteries with the correct polarities. (☞ page 11) → If there is a fluorescent lamp near the remote control detector, the projector may work improperly or inadvertently. → Confirm the position of the remote control detector on the projector. (☞ page 8) → If the 3D Sync Transmitter is pointed to the remote control detector on the projector, the remote function may be impeded.

3D video images

Symptom	Cause and Remedy
The video image does not seem like 3D video images.	<ul style="list-style-type: none"> → Check if the 3D glasses are turned on (☞ page 37). → Make sure that the battery in the 3D glasses is charged. → Check if the input source is HDMI. → Set “2D-3D Display Sel.” to “Auto” or “3D” (☞ page 55). → Check if the input signals are compatible 3D signals (☞ page 81). → If no 3D signal is input from the 3D equipment connected to the projector, restarting the connected 3D equipment may solve the problem. → The 3D glasses may not function effectively if the viewing or projector position is too far from the 3D Sync Transmitter. (☞ page 37). → Check that the 3D Sync Transmitter is placed within the specified range. (☞ page 31). → Turn off the projector, reconnect the 3D Sync Transmitter, and then turn on the projector again. (☞ page 28) → The screen size is not appropriate. Set the zooming magnification to low or watch the image from farther away from the screen (☞ page 84).

Others

Symptom	Cause and Remedy
The fan is noisy.	<ul style="list-style-type: none"> → Check the setting of “Cooling Setting” in the Setup  menu. (☞ page 53) → Make sure that the room temperature is not too high. → Check the installation conditions. (☞ page 13) The number of fan rotation increases to maintain the product reliability of the projector’s components in a room, where the temperature is higher than normal. The fan noise becomes slightly louder. The approximate normal temperature is 25°C.
The lens shift cannot be adjusted.	<ul style="list-style-type: none"> → The lens shift cannot be adjusted over the range of movement. Adjust the lens shift within the range of movement (☞ pages 16, 23).
The projector and connected equipment turn On/Off, play back, and operate at the same time.	<ul style="list-style-type: none"> → “Control for HDMI”, “Device Auto Power Off”, and “PJ Auto Power ON” are set to “On”. Set them to “Off”. For details, see “HDMI Setting” (☞ page 56).

Warning Indicators

The ON/STANDBY or LAMP/COVER indicator lights up or flashes if there is any trouble with your projector.

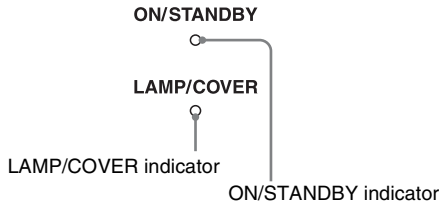

Symptom	Cause and Remedy
LAMP/COVER flashes in red. (A repetition rate of 2 flashes)	<ul style="list-style-type: none"> → Close the lamp cover securely, then tighten the screws securely. (☞ page 70) → Close the filter holder securely. (☞ page 71)
LAMP/COVER flashes in red. (A repetition rate of 3 flashes)	<ul style="list-style-type: none"> → The lamp has reached the end of its useful lifespan. Replace the lamp. (☞ page 69) → The lamp has reached a high temperature. Wait until the lamp cools, and then turn on the power again.
ON/STANDBY flashes in red. (A repetition rate of 4 flashes)	<ul style="list-style-type: none"> → The fan is broken. Consult with qualified Sony personnel.
ON/STANDBY flashes in red. (A repetition rate of 2 flashes)	<ul style="list-style-type: none"> → The internal temperature is unusually high. Check to ensure that if nothing is blocking the ventilation holes or whether or not the projector is being used at high altitudes.
ON/STANDBY flashes in red. (A repetition rate of 6 flashes)	<ul style="list-style-type: none"> → Press the I/⏻ (ON/STANDBY) switch to turn on the projector. If the power is not turned on, disconnect the AC power cord, then confirm the ON/STANDBY lamp is turned off. After about 10 seconds, reconnect the AC power cord and turn on the power again. If the indicators still light up, the electrical system has a problem. Consult with qualified Sony personnel.

Note

When a warning indicator other than the above starts flashing, and the symptom persists even after carrying out the above methods, consult with qualified Sony personnel.

Message Lists

Warning messages

Message	Cause and Remedy
High temp.! Lamp off in 1 min.	<ul style="list-style-type: none"> → Turn off the power. → Check to ensure that nothing is blocking the ventilation holes. (☞ page 14)
Frequency is out of range!	<ul style="list-style-type: none"> → Frequency is out of range. Input a signal that is within the acceptable frequency range of the projector. (☞ page 77)
Please check Input-A Signal Sel.	<ul style="list-style-type: none"> → Set “Input-A Signal Sel.” in the Setup  menu to “Computer” when an RGB signal is input from a computer. (☞ page 54)
Please replace the Lamp/Filter.	<ul style="list-style-type: none"> → It is time to replace the lamp. Replace the lamp. (☞ page 69) → Also, replace the air filter too. Restart cleaning the ventilation holes (intake). (☞ page 69) <p>If this message appears again after you replace the lamp and filter, the lamp replacement process is not complete. Check the lamp replacement process. (☞ page 69)</p> <p>Note</p> <p>To clear this message, press any button either on the remote control or the control panel of the projector once.</p>
Please clean the filter.	<ul style="list-style-type: none"> → It is time to clean the air filter. Clean the air filter. (☞ page 72) <p>Note</p> <p>To clear this message, press any button either on the remote control or the control panel of the projector once.</p>
Please clean the filter. Have you finished? Yes No	<ul style="list-style-type: none"> → It is time to clean the air filter. Clean the air filter. (☞ page 72) → If you cleaned the air filter, select “Yes.” If you did not clean the air filter, select “No.”
Projector temperature is high. Cooling Setting should be “High” if projector is being used at high altitude.	<ul style="list-style-type: none"> → Check to ensure that the ventilation holes on the unit are not covered. (☞ page 8) → When using the projector at high altitude, set the Cooling Setting to “High”. (☞ page 53) <p>Note</p> <p>When temperature inside the projector remains high, the Cooling Setting is switched to “High” in 1 minute, then the fan speed increases.</p>

Caution messages

Message	Cause and Remedy
	<ul style="list-style-type: none"> → No signal is input in the selected input. Check connections. (☞ page 25)
Not applicable!	<ul style="list-style-type: none"> → Press the appropriate button. → The operation to be activated by the button is currently prohibited.

Replacing the Lamp and the Air Filter and Cleaning the Ventilation Holes (intake)

Tools you need to get started:

- Projector Lamp LMP-H202 (optional)
- Standard Phillips screwdriver
- Cloth (for scratch protection)

The lamp used for the light source has a certain lifespan. When the lamp dims, the color balance of the picture becomes strange, or “Please replace the Lamp/Filter.” appears on the screen, the lamp may be exhausted. Replace the lamp with a new one (not supplied) without delay.

Use an LMP-H202 Projector Lamp as the replacement lamp.

The air filter is supplied with the LMP-H202 Projector Lamp. When you replace the lamp, it is also time to replace the air filter.

Whenever you replace the lamp, be sure to replace the air filter with a new one. Also clean the ventilation holes (intake).

Caution

- The lamp remains hot after the projector is turned off with the I/⏻ (ON/STANDBY) switch. If you touch the lamp, you may burn your fingers. When you replace the lamp, wait for at least 1 hour for the lamp to cool.
- Do not touch the surface of the lens. If you touch it, wipe off the fingerprints with a soft cloth.
- Pay special attention to replacing the lamp when the projector is installed on the ceiling.
- When removing the lamp unit, make sure it remains horizontal, then pull straight up. Do not tilt the lamp unit. If you pull out the lamp unit while tilted and if the lamp breaks, the pieces may scatter, causing injury.
- When you remove the air filter, be careful not to let any dust fall into the projector.
- Replacing the air filter is crucial to maintain the good performance of the projector or to prevent malfunction to it. When a warning

message for replacing the air filter appears, replace the air filter immediately.

- 1 Turn off the projector and unplug the AC power cord.
- 2 When setting the projector on a flat surface such as a desk etc., put a cloth to prevent the surface from being scratched. Reverse the projector as illustrated, then place it on the cloth.

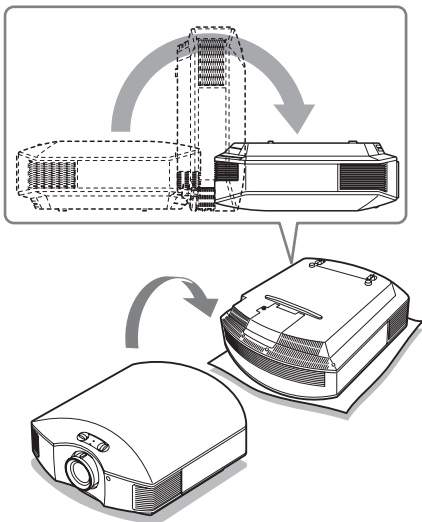

Notes

- When the lamp is damaged the broken pieces of the lamp may become scattered, if you do not reverse the projector. This may cause injury.
- Be sure that the projector is placed on a stable surface.

- 3** Loosen the screw on the lamp cover with a Phillips screwdriver, and then open the lamp cover.

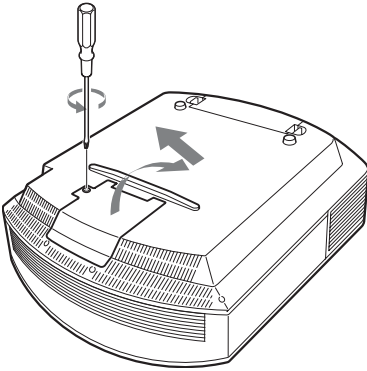

- 5** Hold the handle of the new lamp and push it in securely until it reaches the end, and then tighten the 3 screws.

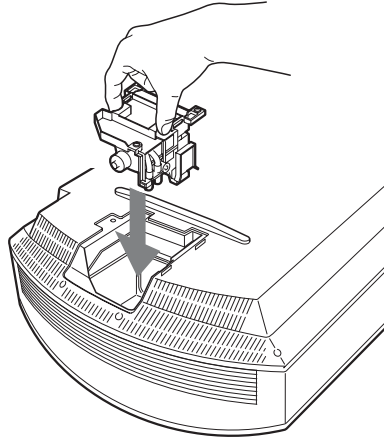

- 4** Loosen the 3 screws on the lamp with the Phillips screwdriver. Hold up the handle, then pull the lamp straight out.

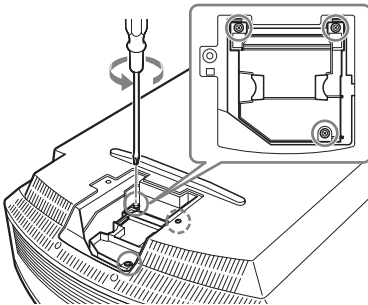

Note

Be careful not to touch the optical block inside the unit.

- 6** Close the lamp cover, then tighten the screws.

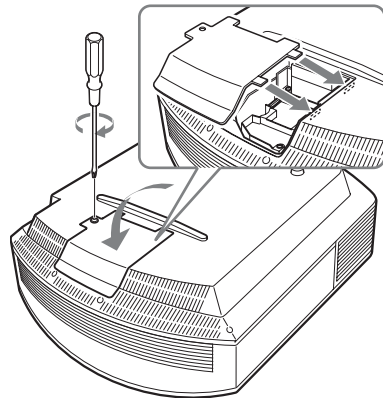

7 Remove the filter holder.

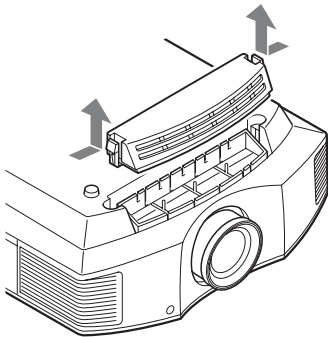

8 Remove the air filter.

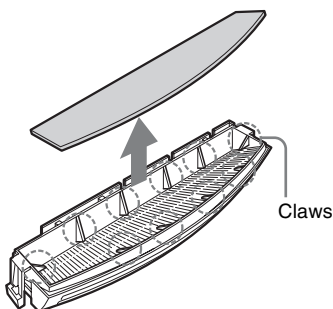

9 Attach the new air filter so that it fits into the each claws (10 positions) on the filter holder.

Note

Attach the air filter aligning it with the shape of the filter holder.
Also, do not touch the fan after removing the air filter that is set deep inside the projector.

10 Attach the filter holder.

Note

The projector will not turn on unless the filter holder is securely closed.

11 Wipe dust off the ventilation holes (intake) with a soft cloth.

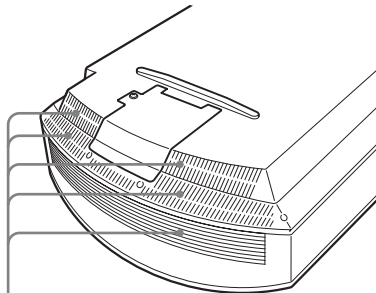

Ventilation holes (intake)

12 Place the project back on its original position.

13 Turn on the projector, then select the desired setting item on the Setup menu. The menu screen below will be appeared.

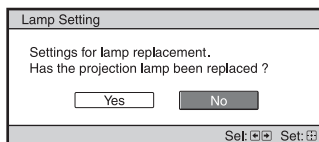

14 Select "Yes".

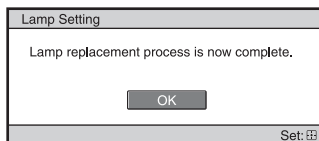

Caution

Do not put your hands into the lamp replacement slot, and do not allow any liquid or other objects into the slot to avoid electrical shock or fire.

Notes

- Be sure to use an LMP-H202 Projector Lamp for replacement. If you use lamps other than the LMP-H202, the projector may malfunction.
- Be sure to turn off the projector and unplug the power cord before replacing the lamp, then check the ON/STANDBY lamp has already been turned off.
- The projector will not turn on unless the lamp is securely installed in place.
- The projector will not turn on unless the lamp cover is securely closed.
- To cancel a message displayed on the screen, press either the button on the remote control or the one on the control panel on the projector.

Note

The lamp contains mercury. The disposal rules for used fluorescent tubes depend on where you live. Follow the waste disposal policy in your area.

Disposal of the used lamp

For the customers in the USA

Lamp in this product contains mercury. Disposal of these materials may be regulated due to environmental considerations. For disposal or recycling information, please contact your local authorities or the Telecommunications Industry Association (www.eiae.org).

Cleaning the Air Filter

When “Please clean the filter.” appears on the screen, you should clean the air filter. The air filter should be cleaned every 1,500 hours. This value varies depending on the environment or how the projector is used. 1,500 hours are approximate. After washing the air filter with a mild detergent solution, dry it in a shaded place.

Notes

- When you clean the air filter, make sure you do not damage it. For details on how to attach and remove the air filter, see “Replacing the Lamp and the Air Filter and Cleaning the Ventilation Holes (intake)” Steps 7 to 10. (☞ page 71)
- When you remove the air filter, be careful not to let any dust fall into the projector.
- Cleaning the air filter is crucial to maintain the good performance of the projector or to prevent malfunction to it. When a warning message for cleaning the air filter appears, clean the air filter immediately.

Fitting the Lens Cap

When fitting the lens cap onto the lens, position the lens cap so that the concave on the side of the lens cap will fit the zoom lever, as shown in the illustration.

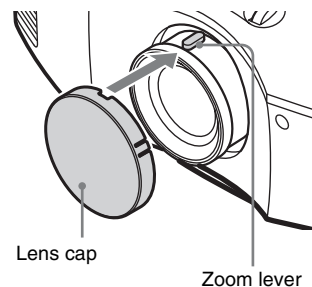

Cleaning and the Screen of the Projector

Cleaning the lens

The lens surface is especially treated to reduce reflection of light.

As incorrect maintenance may impair the performance of the projector, take care with respect to the following:

- Wipe the lens gently with a soft cloth such as a cleaning cloth or glass cleaning cloth.
- Stubborn stains may be removed with a soft cloth such as a cleaning cloth or glass cleaning cloth lightly dampened with water.
- Never use solvent such as alcohol, benzene or thinner, or acid, alkaline or abrasive detergent, or chemical cleaning cloth, as they will damage the lens surface.

Cleaning the cabinet

- To remove dust from the cabinet, wipe gently with a soft cloth. If dust is persistent, wipe with a soft cloth slightly moistened with a diluted mild detergent solution.
- Never use any type of abrasive pad, alkaline/acid cleaner, scouring powder, or volatile solvent, such as alcohol, benzene, thinner or insecticide.
- Using such materials or maintaining prolonged contact with rubber or vinyl materials may result in damage to the screen surface and cabinet material.

Black points and bright points (red, blue, or green) on the screen

The projector is manufactured using high-precision technology.

You may, however, see tiny black points and/or bright points (red, blue, or green) that continuously appear on the projector.

This is a normal result of the manufacturing process and does not indicate a malfunction.

How to Use the USB Charging AC Power Adaptor

Use the provided USB charging AC power adaptor to charge your 3D glasses.

Caution

Avoid connecting the USB cable supplied with the 3D glasses to a USB connector in any other adaptor than the provided. It may cause fire, a rise in temperature or damage to the cable and glasses.

1 Turn off the power of the 3D glasses.

2 Open the USB connector cover and connect the provided USB cable.

Open the cover.

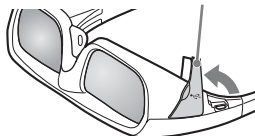

USB cable supplied with the 3D glasses

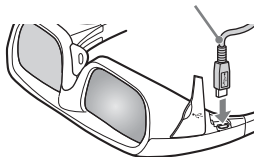

3 Connect the USB cable to the USB connector of the USB charging AC power adaptor.

To USB charging AC power adaptor

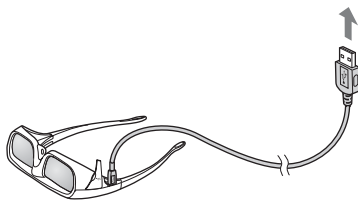

4 Plug the USB charging AC power adaptor into an AC outlet.

Charging starts. The LED indicator on the 3D glasses lights up in yellow while the glasses are being charged.

Precautions about USB charging AC power adaptor

Installation

Do not place the USB charging AC power adaptor in a location where it is:

- Subject to extreme high temperature (E.g., in a car with its windows closed)
- Subject to direct sunlight or near a heat source
- Subject to mechanical vibration or shock

Operation

- To prevent damage, be careful not to drop or otherwise cause a mechanical shock to the unit.
- After using, disconnect the unit from the AC outlet and the equipment.
- Disconnect the unit from the AC outlet by pulling on the plug. Do not pull on the cord.
- To avoid short-circuiting, do not allow the terminals of the USB charging AC power adaptor or connector to touch any metal object.

Cleaning

- Clean the unit with a soft, dry cloth. If the unit is very dirty, wipe it off with a soft cloth lightly moistened with a mild detergent solution, and then wipe with a soft dry cloth.
- Do not use any type of solvent such as alcohol, thinner, or benzine as it may damage the finish of the cabinet.
- If you use any chemical cleaner, observe the instructions provided with the product.
- If the cabinet of the unit is splashed with any type of solvent such as insecticide, or remains in contact for a long time with rubber or vinyl, the finish of the cabinet may be damaged.

Specifications

System

Projection system	SXRD panel, 1 lens, projection system
LCD panel	0.61-inch (15.4 mm) SXRD panel 6,220,800 pixels (2,073,600 pixels × 3)
Lens	1.6 times zoom lens (manual) f=18.7 mm to 29.7 mm F2.52 to F3.02
Lamp	200 W Ultra High Pressure Lamp
Projection picture size	40 inches to 300 inches (1,016 mm to 7,620 mm) (measured diagonally)
Acceptable video signals	15 kHz RGB/component 50/60 Hz, Progressive component 50/60 Hz, 480/60i, 576/50i, 480/60p, 576/50p, 720/60p, 720/50p, 1080/60i, 1080/50i, 1080/24PsF (48i), 1080/60p (HDMI input only), 1080/50p (HDMI input only), 1080/24p (HDMI input only)
Acceptable computer signals	fH: 19 kHz to 72 kHz fV: 48 Hz to 92 Hz Maximum resolution 1,920 × 1,080 (HDMI input only) For details, see "Preset Signals". (Ⓞ page 77)

Input

Y Pb/Cb Pr/Cr	Component: phono type Y with Sync: 1 V _p -p±2dB sync negative (75 ohms terminated) Pb/Cb: 0.7 V _p -p±2dB (75 ohms terminated) Pr/Cr: 0.7 V _p -p±2 dB (75 ohms terminated)
HDMI	Digital RGB/Y C _B (P _B) C _R (P _R)
INPUT A	HD D-sub 15-pins Analog RGB/component: R/C _R (P _R): 0.7 V _p -p±2 dB (75 ohms terminated) G: 0.7 V _p -p±2 dB (75 ohms terminated) G with sync/Y: 1 V _p -p±2 dB sync negative (75 ohms terminated) B/C _B (P _B): 0.7 V _p -p±2 dB (75 ohms terminated)

SYNC/HD: Composite sync input:
TTL level, positive/negative
Horizontal sync input: TTL level,
positive/negative
VD: Vertical sync input: TTL
level, positive/negative

3D SYNC	RJ45 connector
IR IN	Minijack
REMOTE	RS-232C: D-sub 9-pins (female)

General

Dimensions	407.4 mm × 179.2 mm × 463.9 mm (16 1/8 × 7 1/8 × 18 3/8 inches) (w/h/d)
Mass	Approx. 10 kg (22 lb 1 oz)
Power requirements	AC 100 V to 240 V, 3.0 A to 1.3 A, 50/60 Hz
Power consumption	Max. 300 W Standby mode: 8 W Standby mode (low): 0.5 W
Operating temperature	5 °C to 35 °C (41 °F to 95 °F)
Operating humidity	35% to 85% (no condensation)
Storage temperature	-20 °C to +60 °C (-4 °F to +140 °F)
Storage humidity	10% to 90%

Supplied accessories

Remote control RM-PJ20 (1)
Size AA (R6) manganese batteries
(2)
AC power cord (1)
Lens cap (1)
USB charging AC power adaptor
(1)
Operating Instructions (1)
3D glasses (2)*
USB charging cable (1)*
Pouch for the 3D glasses (2)*
3D Sync Transmitter (1)*
* VPL-HW30AES only

Design and specifications are subject to change
without notice.

Optional accessories

Projector Lamp LMP-H202 (for replacement)
Projector Suspension Support PSS-H10

3D glasses

TDG-PJ1

3D Sync Transmitter

TMR-PJ1

Warning on power connection

Use a proper power cord for your local power supply.

	The United States, Canada	Continental Europe	UK, Ireland, Australia, New Zealand	Japan	China
Plug type	YP-3	YP-12A	*	YP-359	VM0722
Female end	YC-13	YC-13D	VM0303B	YC-13	VM0724
Cord type	SVT	H05VV-F	CEE (13) 53 rd (OC)	VCTF	227 IEC 53(RVV)
Rated Voltage & Current	10A/125V	10A/250V	10A/250V	12A/125V	10A/250V
Safety approval	UL/CSA	VDE	VDE	DENANHO	CCC

* Use a rated plug that complies with the regulation of each country/region and the specifications.

Preset Signals

The following table shows the signals and video formats which you can project using this unit.

When a signal other than the preset signal shown below is input, the picture may not be displayed properly.

Memory No.	Preset signal (resolution)		fH (kHz)	fV (Hz)	Sync	H Size
3	480/60i	480/60i (720 × 480i)	15.734	59.940	SonG/Y or composite sync	–
4	576/50i	576/50i (720 × 576i)	15.625	50.000	SonG/Y or composite sync /composite video	–
5	480/60p	480/60p (Progressive NTSC) (720 × 480p)	31.470	60.000	SonG/Y	–
6	576/50p	576/50p (Progressive PAL) (720 × 576p)	31.250	50.000	SonG/Y	–
7	1080/60i	1035/60i (1920 × 1035i) 1080/60i (1920 × 1080i)	33.750	60.000	SonG/Y	–
8	1080/50i	1080/50i (1920 × 1080i)	28.130	50.000	SonG/Y	–
9	1080/24PsF (48i)	1080/24PsF (48i) (1920 × 1080i)	27.000	48.000	SonG/Y	–
10	720/60p	720/60p (1280 × 720p)	45.000	60.000	SonG/Y	–
11	720/50p	720/50p (1280 × 720p)	37.500	50.000	SonG/Y	–
12	1080/60p	1080/60p (1920 × 1080p)	67.500	60.000	–	–
13	1080/50p	1080/50p (1920 × 1080p)	56.260	50.000	–	–
14	1080/24p	1080/24p (1920 × 1080p)	26.973	23.976	–	–
18	720/60p (Frame packing)	720/60p (1280 × 720p)	90.000	60.000	–	–
19	720/50p (Frame packing)	720/50p (1280 × 720p)	75.000	50.000	–	–
20	1080/24p (Frame packing)	1080/24p (1920 × 1080p)	53.946	23.976	–	–

Memory No.	Preset signal (resolution)		fH (kHz)	fV (Hz)	Sync	H Size
26	640 × 480	VESA 60	31.469	59.940	H-neg, V-neg	800
28		VESA 72	37.861	72.809	H-neg, V-neg	832
29		VESA 75 (IBM M3)	37.500	75.000	H-neg, V-neg	840
30		VESA 85 (IBM M4)	43.269	85.008	H-neg, V-neg	832
31	800 × 600	VESA 56	35.156	56.250	H-pos, V-pos	1024
32		VESA 60	37.879	60.317	H-pos, V-pos	1056
33		VESA 72	48.077	72.188	H-pos, V-pos	1040
34		VESA 75 (IBM M5)	46.875	75.000	H-pos, V-pos	1056
35		VESA 85	53.674	85.061	H-pos, V-pos	1048
37	1024 × 768	VESA 60	48.363	60.004	H-neg, V-neg	1344
38		VESA 70	56.476	70.069	H-neg, V-neg	1328
39		VESA 75	60.023	75.029	H-pos, V-pos	1312
45	1280 × 960	VESA 60	60.000	60.000	H-pos, V-pos	1800
47	1280 × 1024	VESA 60	63.974	60.013	H-pos, V-pos	1696
50	1400 × 1050	SXGA +	65.317	59.978	H-neg, V-pos	1864
55	1280 × 768	1280 × 768/60	47.776	59.870	H-neg, V-pos	1664
56	1280 × 720	1280 × 720/60	44.772	59.855	H-neg, V-pos	1664

Preset memory numbers for each input signal

Analog signal

Signal	Preset memory number
Component signal (INPUT A and Y Pb/Cb Pr/ Cr connectors)	3 to 11
Video GBR signal (INPUT A connector)	3 to 11
Computer signal (INPUT A connector)	26, 28 to 35, 37 to 39, 55, 56

Digital signal

Signal	Preset memory number
Component signal (HDMI 1, 2 connectors)	3 to 8, 10 to 14, 18 to 20
Video GBR signal (HDMI 1, 2 connectors)	3 to 8, 10 to 14, 18 to 20
Computer signal (HDMI 1, 2 connectors)	10 to 13*, 26, 32, 37, 45, 47, 50, 55

* Some digital signals input from computers may be displayed as preset memory number of Component or Video GBR signal.

Input Signals and Adjustable/Setting Items

The items in the menus available to adjust differ depending on the input signal. The following tables indicate them.

The items that cannot be adjusted are not displayed in the menu.

Picture Menu

Item	Input signal		
	Component signal	Video GBR signal	Computer signal
Advanced Iris	●	●	●
Lamp Control	●	●	●
Motion Enhancer	●	●	–
Contrast	●	●	●
Brightness	●	●	●
Color	●	●	–
Hue	●	●	–
Color Temp.	●	●	●
Sharpness	●	●	–
NR	● (preset memory numbers 3, 4, 7, 8, 9 only)	● (preset memory numbers 3, 4, 7, 8, 9 only)	–
MPEG NR	●	●	●
Film Mode	● (preset memory numbers 3, 4, 7, 8, 9 only)	● (preset memory numbers 3, 4, 7, 8, 9 only)	–
Black Level Adj.* ¹	●	●	–
White Level Adj.* ¹	●	●	–
Gamma Correction * ¹	●	●	●
x.v.Color	●	–	–
Color Space	●	●	●
RCP	●	●	●

● : Adjustable/can be set

– : Not adjustable/cannot be set

Screen menu

Item	Input signal		
	Component signal	Video GBR signal	Computer signal
Wide Mode	●	●	● * ³
Over Scan	●	●	—
Screen Area * ²	● (preset memory numbers 7, 8, 9, 12, 13, 14 only)	● (preset memory numbers 7, 8, 9, 12, 13, 14 only)	—
V Center * ⁴	●	●	●
Vertical Size * ⁴	●	●	—
APA	—	—	● * ⁵
Phase	—	—	● * ⁵
Pitch	—	—	● * ⁵
Shift	● * ⁵	● * ⁵	●

● : Adjustable/can be set

— : Not adjustable/cannot be set

*¹: The setting can be made only when “x.v.Color” is set to “Off”.



*²: The setting can be made only when “Over Scan” is set to “On” and “Wide Mode” is set to “Full” in the Screen  menu.

*³: If the input signal is from a computer, the setting cannot be made when the aspect ratio is 16:9 or wider (fixed at “Full 1”).

*⁴: The setting can be made only when “Zoom” is selected in “Wide Mode”.

*⁵: The setting can be made only for analog signal.

Note

When connecting a cable such as an HDMI cable, etc., check the type of the signal in the Information  menu ( page 60) and Digital signal ( page 78), and check items that are adjustable/can be set.

Compatible 3D Signals

The projector accepts the following types of 3D signals.

Resolution	3D signal format
720/60, 50P	Side-by-Side format
	Over-Under format*
	Frame packing*
1080/60, 50i	Side-by-Side format*
1080/24P	Over-Under format*
	Frame packing*
1080/60, 50P	Side-by-Side format
	Over-Under format

*: Mandatory 3D format of the HDMI standards.

3D Signals and Adjustable/Setting Items

Some items on the menus may not be available to adjust/set, depending on the 3D signals. The items that cannot be adjusted are not displayed on the menu. The following tables indicate those items.

Item	3D signals			
	720/60, 50P	1080/60, 50i	1080/24P	1080/60, 50P
Advanced Iris	–	–	–	–
Lamp Control	– (fixed at “High”)	– (fixed at “High”)	– (fixed at “High”)	– (fixed at “High”)
Motion enhancer	–	–	●	–
NR	–	–	–	–
MPEG NR	●	●	– *	●
Film mode	–	–	–	–
x.v.Color	–	–	● (component signal only)	–
Wide mode	– (fixed at “Full”)	– (fixed at “Full”)	– (fixed at “Full”)	– (fixed at “Full”)
Over scan	–	–	–	–
Screen area	– (fixed at “Full”)	– (fixed at “Full”)	– (fixed at “Full”)	– (fixed at “Full”)
V keystone	– (fixed at “0”)	– (fixed at “0”)	● (fixed at “0”)	– (fixed at “0”)

●: Adjustable/can be set

–: Not Adjustable/cannot be set

*: The setting can be made for Over-Under format

When the projector is set to convert 2D video images to 3D video images, some items on the menus may be not available to adjust/set, depending on the “3D Format” settings on the Function  menu. The items that cannot be adjusted are not displayed on the menu. The following tables indicate these items.

Item	3D format		
	Side-by-Side	Over-Under	Simulated 3D
Advanced Iris	–	–	–
Lamp Control	–	–	–
Motion enhancer	● (preset memory number 14 only)	–	●
NR	–	–	● (preset memory numbers 7, 8 only)
MPEG NR	●	●	●
Film mode	–	–	–
x.v.Color	● (preset memory number 14 only)	–	●
Wide mode	–	–	–
Over scan	–	–	–
Screen area	–	–	–
V keystone	● (preset memory number 14 only)	–	–

Ceiling Installation

Use the PSS-H10 Projector Suspension Support when you install the projector on a ceiling. The projection distances for ceiling installation are shown below.

- L': Distance between the screen and the installation hole at the ceiling side of the ceiling mount unit (front side)
- y': Distance between the ceiling and the center of the screen such that the picture will not be truncated or blocked

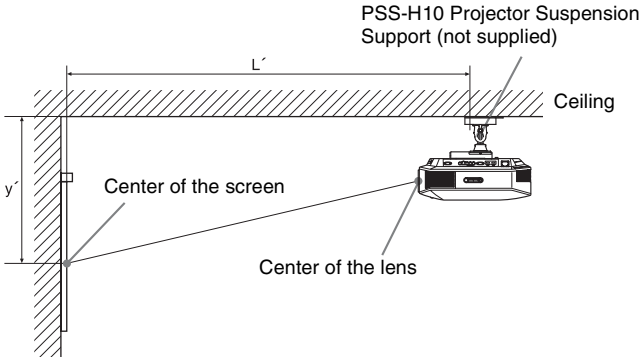

When using the 16:9 aspect ratio screen size

Screen Size SS (inches)		40	60	80	100	120	150	200	250	300
(mm)		1016	1524	2032	2540	3048	3810	5080	6350	7620
L'	(minimum)	1385 (54 ¹⁷ / ₃₂)	2008 (79 ¹ / ₁₆)	2632 (103 ⁵ / ₈)	3256 (128 ⁵ / ₃₂)	3879 (152 ²³ / ₃₂)	4814 (189 ¹⁷ / ₃₂)	6373 (250 ²⁹ / ₃₂)	7932 (312 ⁹ / ₃₂)	9491 (373 ²¹ / ₃₂)
	(maximum)	2013 (79 ⁹ / ₃₂)	2955 (116 ⁵ / ₁₆)	3896 (153 ³ / ₈)	4837 (190 ⁷ / ₁₆)	5779 (227 ¹ / ₂)	7190 (283 ³ / ₃₂)	9544 (375 ³ / ₄)	11897 (468 ³ / ₈)	14250 (561 ¹ / ₃₂)
y'	(minimum)	249 (9 ⁷ / ₈)	374 (14 ³ / ₄)	498 (19 ⁵ / ₈)	623 (24 ⁵ / ₈)	747 (29 ¹ / ₂)	934 (36 ⁷ / ₈)	1245 (49 ¹ / ₈)	1557 (61 ³ / ₈)	1868 (73 ⁵ / ₈)
	(maximum)	592 (23 ³ / ₈)	754 (29 ³ / ₄)	916 (36 ¹ / ₈)	1078 (42 ¹ / ₂)	1240 (48 ⁷ / ₈)	1483 (58 ¹ / ₂)	1887 (74 ³ / ₈)	2292 (90 ¹ / ₄)	2697 (106 ¹ / ₄)

Unit: mm (inches)

To calculate the installation positions

$$L' \text{ (minimum)} = 31.1781 (1 \frac{7}{32}) \times SS + 137.7 (5 \frac{13}{32})$$

$$L' \text{ (maximum)} = 47.0644 (1 \frac{27}{32}) \times SS + 130.8 (5 \frac{5}{32})$$

$$y' \text{ (minimum)} = 6.2263 (1 \frac{1}{4}) \times SS$$

$$y' \text{ (maximum)} = 8.0942 (5 \frac{1}{16}) \times SS + 268.5 (10 \frac{9}{16})$$

When using the 4:3 aspect ratio screen size

Screen Size SS (inches)		40	60	80	100	120	150	200	250	300
(mm)		1016	1524	2032	2540	3048	3810	5080	6350	7620
L'	(minimum)	1664 (65 ¹ / ₂)	2427 (95 ⁹ / ₁₆)	3190 (125 ¹⁹ / ₃₂)	3953 (155 ²¹ / ₃₂)	4717 (185 ¹¹ / ₁₆)	5861 (230 ³ / ₄)	7769 (305 ⁷ / ₈)	9677 (380 ³¹ / ₃₂)	11585 (456 ³ / ₃₂)
	(maximum)	2435 (95 ²⁷ / ₃₂)	3587 (141 ⁷ / ₃₂)	4739 (186 ⁹ / ₁₆)	5891 (231 ²⁹ / ₃₂)	7043 (277 ⁹ / ₃₂)	8771 (345 ⁵ / ₁₆)	11651 (458 ¹¹ / ₁₆)	14531 (572 ¹ / ₁₆)	17411 (685 ¹⁵ / ₃₂)
y'	(minimum)	305 (12 ¹ / ₈)	457 (18)	610 (24 ¹ / ₈)	762 (30)	914 (36)	1143 (45)	1524 (60)	1905 (75)	2286 (90)
	(maximum)	665 (26 ¹ / ₄)	863 (34)	1061 (41 ⁷ / ₈)	1259 (49 ⁵ / ₈)	1457 (57 ³ / ₈)	1754 (69 ¹ / ₈)	2250 (88 ⁵ / ₈)	2745 (108 ¹ / ₈)	3240 (127 ⁵ / ₈)

Unit: mm (inches)

To calculate the installation positions

$$L' \text{ (minimum)} = 38.1569 (1 \frac{1}{2}) \times SS + 137.7 (5 \frac{13}{32})$$

$$L' \text{ (maximum)} = 57.5992 (2 \frac{9}{32}) \times SS + 130.8 (5 \frac{5}{32})$$

$$y' \text{ (minimum)} = 7.62 (5 \frac{1}{16}) \times SS$$

$$y' \text{ (maximum)} = 9.906 (3 \frac{3}{8}) \times SS + 268.5 (10 \frac{9}{16})$$

Attaching the PSS-H10 projector suspension support

For details on installation on a ceiling, refer to the Installation manual for Dealers of the PSS-H10. Make sure to consult with a qualified Sony personnel for installation.

The installation measurements are shown below when installing the projector on a ceiling using the PSS-H10.

Top view

Install the projector so that the center of the lens is parallel to the center of the screen.

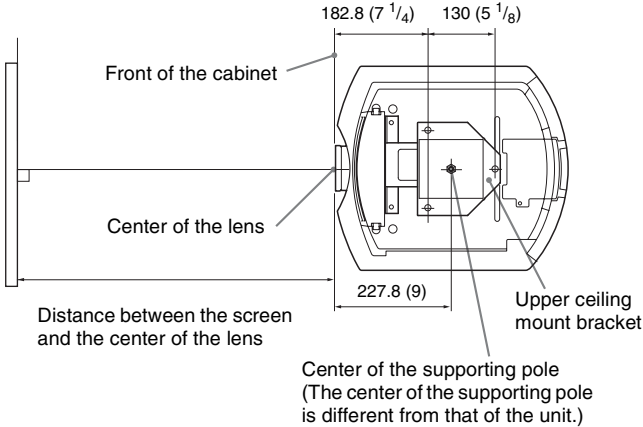

Front view

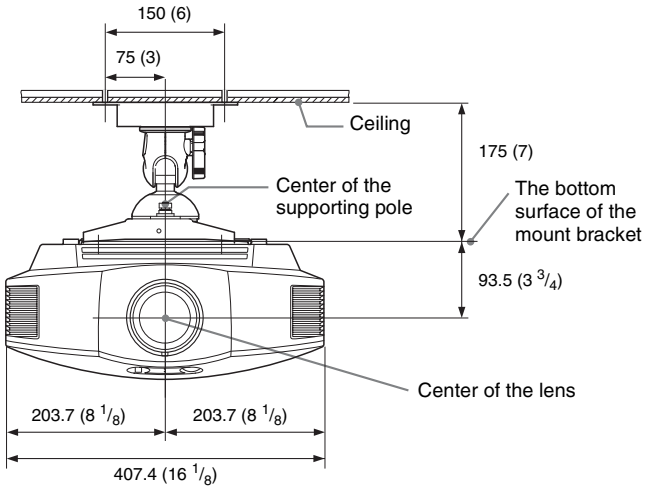

Side view

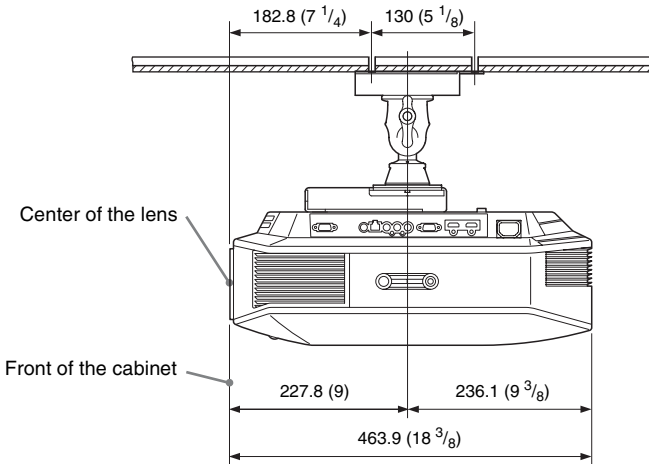

Index

Numerics

3D Glasses	
Using the 3D glasses	37
3D Settings	
2D-3D Display Sel.	55
3D Depth Adjust	56
3D Format	55
3D glasses Bright	56
Simulated 3D Effect	56

A

Acceptable 3D Signals	81
Adjust Signal	
APA	52
Phase	52
Pitch	52
Shift	52
Adjuster	24
Adjusting	
picture position	20
picture quality	39
Advanced Iris	47
APA	52
Auto Input Search	57

B

Background	57
Black Level Adj.	49
Blanking	58
Brightness	47

C

Ceiling Installation	83
Cinema Black Pro	47
Color Space	49
Color Temp.	48
Connecting	
Computer	27
Optional 3D sync transmitter	28
Video equipment	25
Contrast	47
Control for HDMI	56
Cooling Setting	53

E

Expert Setting	48, 49
----------------------	--------

F

fH	60
fV	60

G

Gamma Correction	49
------------------------	----

H

HDMI	25
Hue	48

I

Image Flip	58
Input-A Signal Sel.	54

L

Lamp Control	47
Lamp Timer	60
Language	53
Location of Controls	
Front/Right side	8
Rear/Bottom	9

M

Menu	
Advanced Picture	50
Function	55
Information	60
Installation	58
Picture	46
Screen	51
Setup	53
Messages	
Caution	68
Warning	68
Motion Enhancer	47
Motionflow	47
MPEG NR	48

N

NR	48
----------	----

O

Over Scan	52
-----------------	----

P	
Panel Alignment	59
Picture Mode	
CINEMA	38
Cinema	46
DYNAMIC	38
Dynamic	46
GAME	38
Game	46
PHOTO	38
Photo	46
STANDARD	38
Standard	46
USER	38
User	46
Precautions	7
Preset Memory	61
Preset Signals	77

R	
RCP	50
Remote control	
inserting the batteries	11
location of controls	10
Reset	
resettable items	45
resetting the items	45

S	
Screen Area	52
Selecting the menu language	29
Sharpness	48
Specifications	75
Standby Mode	53
Status	53
Supplied accessories	11

T	
Troubleshooting	64

V	
V Keystone	58

W	
White Level Adj.	49
WIDE MODE	33
Wide Mode	
Full	51
Full 1	51
Full 2	51

Normal	51
Wide Zoom	51
Zoom	51

X	
x.v.Color	49, 62

